

# → SENTINEL-3

ESA's Global Land and Ocean Mission for GMES Operational Services



SP-1322/3  
October 2012

# → SENTINEL-3

**ESA's Global Land and Ocean Mission for GMES Operational Services**

## Acknowledgements

In the preparation of this publication, ESA acknowledges the contributions of the following organisations and individuals:

ESA GMES Programme, Sentinel-3 Project and Science Division Teams at ESTEC, Noordwijk, the Netherlands: J.-P. Batoufflet, B. Berruti, F. Borde, P. Boyer, A. de Luca, C. Donlon, M.-H. Ferreira, J-F. Flamand, J. Frerick, K. Gantois, U. Klein, G. Levrini, C. Mavrocordatos, S. Mejnertsen, J. Nieke, P. Oldeman, E. Pastorboni, M. Pucci, H. Rebhan, O. Rombout, B. Seitz, J. Stroede, P. Vuilleumier, C. Wildner

ESA GMES programme, Sentinel-3 PDGS and Mission Management Team at ESRI, Frascati, Italy: J. Aschbacher, P. Bargellini, A. Buongiorno, A. Ciccolella, P. Féménias, G. Filippazzo, P. Goryl, G. Kohlhammer, H. Laur, S. Mecklenburg, E. Monjoux, R. Sciarra

ESA Sentinel-3 Flight Operations Segment Team at ESOC, Darmstadt, Germany: P.P. Emanuelli, J. Morales, J. Piñeiro, M. Romanazzo

National space agencies and international space organisations working in partnership with ESA:

- CNES, Toulouse, France: F. Boy, L. Clarac, S. Coutin-Faye, J.D. Desjonquères, A. Guillot, C. Jayles, C. Manfredi, F. Mercier, N. Picot
- Eumetsat, Darmstadt, Germany: H. Bonekamp, M. Buemi, R. Cunningham, V. Fournier-Sicre, M. Horny, C. Jackson, D. Montero, D. Provost, V. Santacesaria, H. Wilson

Members of the industrial consortium led by Thales Alenia Space (France) as Prime Contractor.

Cover: Artist's impression of one Sentinel-3 satellite operating in orbit.

### An ESA Communications Production

**Publication** *Sentinel-3: ESA's Global Land and Ocean Mission for GMES Operational Services* (ESA SP-1322/3, October 2012)

**Production Editor** K. Fletcher

**Editing/Layout** Contactivity bv, Leiden, the Netherlands

**Publisher** ESA Communications  
ESTEC, PO Box 299, 2200 AG Noordwijk, the Netherlands  
Tel: +31 71 565 3408 Fax: +31 71 565 5433 [www.esa.int](http://www.esa.int)

**ISBN** 978-92-9221-420-3

**ISSN** 0379-6566

**Copyright** © 2012 European Space Agency

## Foreword

The Global Monitoring for Environment and Security (GMES) programme has been established to fulfil the need of European policy makers to access accurate and timely information to better manage the environment, understand and mitigate the effects of climate change and ensure civil security. As part of GMES, ESA is undertaking the development of Sentinel-3, an operational system of two polar-orbiting satellites that will combine optical medium-resolution observations and altimetry measurements. The Sentinel-3 mission will ensure the continuity of, and improve upon, some of the key Envisat and SPOT applications. The mission will also promote the further development, operation and sustainability of a portfolio of GMES services related to both marine and land monitoring with contributions to atmospheric, emergency, security and cryospheric applications.



# Contents

<b>Foreword</b>	<b>iii</b>
<b>1 Introduction</b>	<b>3</b>
Structure of this Report	4
<b>2 GMES Programme Context</b>	<b>5</b>
2.1 GMES Missions	6
2.2 GMES Space Component Ground Segment	7
2.3 Sentinel Data Policy and Reuse of EO data	8
2.4 Sentinel-3 Development Context	8
2.4.1 International Cooperation	8
2.4.2 Industrial Setup	9
<b>3 Sentinel-3 Mission Requirements</b>	<b>11</b>
3.1 User Requirements	11
3.2 Mission Requirements	12
3.2.1 Ocean Altimetry Measurements	13
3.2.2 Sea Surface Temperature	15
3.2.3 Ocean Colour	17
3.2.4 Land Measurement Priorities	18
3.2.5 Monitoring of Atmospheric Properties	19
3.2.6 River and Lake Level Monitoring	20
3.3 Mission Aim and Objectives	20
3.4 Timeliness	23
<b>4 Sentinel-3 Mission Design</b>	<b>25</b>
4.1 Overview	25
4.2 Orbit Definition	25
4.3 Satellite Operations	27
<b>5 Sentinel-3 Space Segment</b>	<b>31</b>
5.1 Satellite Configuration	31
5.2 Command and Control and Data Handling Architecture	34
5.2.1 Automation of Operations	36
5.2.2 Fault Detection Isolation and Recovery	37
5.3 Central Software	38
5.4 Energy and Power Subsystem	38
5.5 Communications	41

5.6 Attitude and Orbit Control System and Propulsion . . . . . 42

5.7 Mechanical and Thermal Subsystem . . . . . 45

    5.7.1 Thermal Design . . . . . 45

    5.7.2 Structural Design . . . . . 45

**6 Sentinel-3 Payload . . . . . 47**

    6.1 The Sea and Land Surface Temperature Radiometer . . . . . 47

        6.1.1 Instrument Concept . . . . . 48

        6.1.2 Calibration and Characterisation . . . . . 52

    6.2 The Ocean and Land Colour Instrument. . . . . 53

        6.2.1 Instrument Concept . . . . . 53

        6.2.2 Calibration and Characterisation . . . . . 57

    6.3 The Synthetic Aperture Radar Altimeter. . . . . 58

        6.3.1 SRAL Architecture and Modes . . . . . 59

        6.3.2 SRAL Budgets and Performance . . . . . 61

        6.3.3 Overview of SRAL Components . . . . . 62

    6.4 The Microwave Radiometer . . . . . 64

        6.4.1 Radiometer Electronics Unit. . . . . 65

        6.4.2 Antenna Assembly . . . . . 66

    6.5 The Precise Orbit Determination Package . . . . . 67

        6.5.1 The GPS Receiver . . . . . 68

        6.5.2 Doppler Orbitography and Radiopositioning Integrated by Satellite . . . . . 69

        6.5.3 Laser Retroreflector. . . . . 70

**7 Sentinel-3 Ground Segment . . . . . 73**

    7.1 Flight Operations Segment . . . . . 73

    7.2 Payload Data Ground Segment . . . . . 74

**8 Sentinel-3 Products . . . . . 77**

    8.1 Level-1 Processing . . . . . 77

    8.2 Level-2 Processing . . . . . 79

    8.3 Calibration and Validation . . . . . 81

    8.4 Satellite Commissioning . . . . . 82

**9 Conclusions . . . . . 85**

**Appendix: Sentinel-3 Industrial Consortium. . . . . 89**

**References. . . . . 93**

**Acronyms and Abbreviations . . . . . 95**



→ **SENTINEL-3**



## 1. Introduction

The Global Monitoring for Environment and Security programme is a joint initiative of the European Commission (EC) and the European Space Agency (ESA), to establish a European capacity for Earth observation. GMES has been designed to provide European policy makers and public authorities with accurate and timely information that is needed to manage the environment, understand and mitigate the effects of climate change and ensure civil security. ESA's role in GMES is to provide the definition and the development of the space- and ground-related system elements.

Sentinel-3 is an Earth observation (EO) satellite mission designed for GMES to ensure the long-term collection and operational delivery of high-quality measurements for GMES ocean, land, atmospheric, emergency and security services. The key Sentinel-3 measurement requirements, corresponding to identified GMES user needs, are:

- Sea surface topography, Significant Wave Height and Surface Wind Speeds derived over the world's oceans to levels of accuracy and precision equivalent to those achieved by the Envisat Radar Altimeter-2 (RA-2) but with enhanced surface topography measurements in coastal zones, sea ice regions and over rivers, their tributaries and lakes.
- Sea Surface Temperatures determined for ocean and coastal waters globally to levels of accuracy and precision equivalent to those achieved by the Envisat Advanced Along-Track Scanning Radiometer (AATSR) over the oceans (i.e.  $<0.3\text{K}$ ) at a spatial resolution of 1 km.
- Visible and Short-Wave Infrared radiances for ocean, inland and coastal waters at a spatial resolution of  $\leq 0.3$  km (simultaneously and co-registered with SST measurements), determined to levels of accuracy and precision equivalent to those of Envisat's Medium-Resolution Imaging Spectrometer (MERIS) with complete ocean coverage in 2–3 days.
- Visible and infrared radiances over global land surfaces in 1–2 days, sea ice and ice sheets equivalent to those provided by the Envisat MERIS and AATSR, and the Système Probatoire d'Observation de la Terre (SPOT) Vegetation instrument.

These requirements have driven the design of the Sentinel-3 mission to create a dependable multi-instrument EO system that will implement and operate:

- a dual-frequency Synthetic Aperture Radar (SAR) Altimeter (SRAL) instrument supported by a dual-frequency passive Microwave Radiometer (MWR) for wet-tropospheric correction, a GPS receiver and a Laser Retro-Reflector for Precise Orbit Determination;
- a highly sensitive Ocean and Land Colour Instrument (OLCI), an imaging spectrometer that will deliver multichannel wide-swath optical measurements of ocean and land surfaces;
- a dual-view Sea and Land Surface Temperature Radiometer (SLSTR) that will deliver accurate surface ocean, land and ice temperature data; and
- a collaborative Ground Segment that will manage the mission, and coordinate the management, development, production and access to core data products in an operational near-realtime delivery context.

Sentinel-3 will provide global coverage optical data with 1–2 day repeat coverage featuring moderate ( $>300$  m) spatial resolution, wide field of view and large spectral discrimination (spanning the visible to infrared waveband), together with precise global coverage altimetry using high-resolution SAR over all coastal and land surfaces. The mission will ensure the continuity of the Envisat and SPOT/Vegetation data streams and will represent a major evolution of Envisat.

A series of satellites is foreseen, each with a nominal seven-year operational lifetime, over a 20-year period, starting with the launch of Sentinel-3A in mid-2014. During full operation, two identical satellites will be maintained in the same orbit with a phase delay of 180°.

## Structure of this Report

This report is one of a series produced by ESA dedicated to the GMES programme. Each report covers various aspects related to one Sentinel mission, starting with the mission objectives, its implementation and the expected outputs to users. In doing this, the report addresses the contributions of ESA, the cooperating agencies and industry to:

- the design and development of the instruments and platform to the highest engineering standards;
- the preparations for the launch, commissioning and nominal operation of the Sentinels and to ensure availability of the obtained data to users; and
- the preparations for the calibration and validation of the instruments and of their data products.

The report has been prepared with contributions from the Sentinel-3 teams working at all ESA sites, the supporting agencies (Eumetsat and CNES) and the industrial consortium led by Thales Alenia Space (France) as the Prime Contractor. The intention has been to present how the mission will deploy in orbit an operational system that will provide an essential and unique contribution to the monitoring of climate and environmental changes in Europe in the coming decades.

The structure of the report reflects the logical process followed in the development of the mission.

Chapter 2 introduces the GMES programme and in particular the GMES Space Component programme, including each of the complementary Sentinel missions. It briefly describes the international agreements in support of the Sentinel-3 programme implementation and the industrial setup used to develop the mission.

Chapter 3 provides an overview of the mission objectives and requirements, and identifies the associated constraints (such as primary outputs, mission duration, orbit selection, ground coverage, etc.).

Chapter 4 describes the overall design of the mission as result from the requirements defined in the previous chapter. The definition of the Sentinel-3 orbit is presented, demonstrating that all important requirements for temporal and spatial coverage are fulfilled.

Chapter 5 introduces the satellite platform and the major functions to manage all onboard instruments. In addition, details of the satellite orbit and attitude determination are outlined as these are particularly important for the altimeter measurements.

Chapter 6 then gives an overview of the design of the Instruments, with particular focus on the calibration methods and hardware implemented on board, in order to achieve the highest possible measurement accuracy.

The Ground Segment of the mission is described in Chapter 7, including the mission operations, satellite commanding as well as instrument data handling aspects (i.e. data reception, processing, archive and data dissemination).

Finally, Chapter 8 examines the data products that will be delivered to users from the Sentinel-3 mission, together with the proposed in-orbit calibration activities and the long-term validation plan.

## 2. GMES Programme Context

Policy makers and public authorities require accurate and timely information to prepare environmental legislation and policies, monitor their implementation and assess their effectiveness. In order to improve its response to the growing challenges of global security and climate change, Europe requires an independent and sustained Earth observation capability to monitor the marine and land environment in an operational context. GMES is a European initiative to establish such a capability (EC, 2005) designed to generate and deliver environmental information using satellite, *in situ* and socio-economic data that is gathered and processed to provide accurate high-quality information products and services tailored to the needs of decision makers.

Within the GMES programme, the GMES Space Component (GSC) is responsible for delivering the necessary Earth observation data to the GMES Service Component, which in turn is responsible for delivering the data and value-added products to users (Fig. 2.1). While GMES is led by the European Commission, ESA is responsible for the coordination of the GMES Space Component. As part of this responsibility, ESA Member States have approved the GMES Space Component programme as an optional ESA programme, to which the EC also contributes financially. ESA is responsible for developing a fully operational space-based capability to feed the GMES Service Component with satellite data. This capability will be achieved by facilitating access to data from GMES Contributing Missions as well as by developing new GMES dedicated Earth observation missions, the Sentinels. The satellite data will be stored in a long-term archive for repeated use of long time-series.

The Sentinels have been designed to meet a set of requirements defined in the Mission Requirement Documents of the individual missions, with a view to satisfying the evolving requirements of the GMES user communities, notably those identified in the strategic implementation plans prepared by the EC GMES Core Services Implementation Groups in 2007, and in the GMES Space Component Programme Declaration approved by the participating ESA Member States.

The GMES capacity is composed of three modules, which together constitute the functional GMES system:

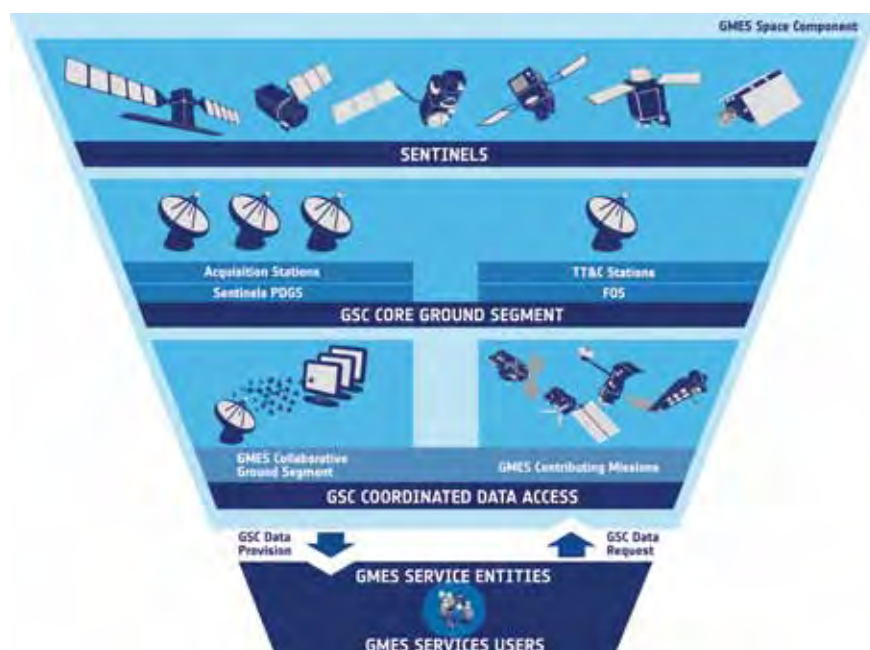

Figure 2.1. The GMES Space Component feeding the GMES Service Component with data products.

- the production and dissemination of information in support of European Union (EU) policies related to the environment and security;
- the mechanisms needed to ensure a permanent dialogue between all stakeholders and in particular between providers and users; and
- the legal, financial, organisational and institutional frameworks necessary to ensure the functioning of the GMES system and its evolution.

Many elements of these three modules already exist but have been conceived, designed and managed in isolation, thus limiting the interoperability and production of relevant information. The coherence, efficiency and sustainability of a shared information system for Europe will be the added value of GMES. Developing compatibility between the existing elements, establishing cooperation between the organisations and filling the gaps where necessary will achieve this goal.

Within the GMES programme, ESA is responsible for the development of the Space Component, a fully operational space-based capability to supply Earth observation data to sustain environmental information services in Europe. These services, implemented in parallel by the European Commission, will provide value-added data and services to the GMES end-users.

## 2.1 GMES Missions

The Sentinels constitute the first series of operational satellites that will respond to the Earth observation needs of the GMES initiative. The GMES Space Component relies strongly on complementary developments within ESA, as well as on the existing and planned space assets of the various national space agencies.

ESA is developing five Sentinel mission families. The concept of Sentinel-1, Sentinel-2, Sentinel-3 and Jason-CS is based on a constellation of two satellites in the same orbital plane. With this configuration it will be possible to fulfil the revisit and coverage requirements and to provide robust and affordable operational services.

Sentinel-4 is an atmospheric chemistry instrument that will be flown on the MTG satellites and will operate from a geostationary orbital position. Sentinel-5P is a precursor atmospheric chemistry mission to be flown in a polar Sun-synchronous orbit (filling the gap between Envisat and MetOp Second Generation). It will be dedicated to monitoring the composition of the atmosphere for GMES Atmospheric Services.

Sentinel-5 is an operational atmospheric chemistry instrument to be flown on the MetOp Second Generation satellites and will operate from a Sun-synchronous polar orbit.

The lifetime of the individual satellites is specified as 7.25 years (5 years for Jason-CS), with consumables on board each satellite that will allow for mission extensions of up to 12 years (7 years for Jason-CS). The life cycle of each generation of satellites is planned to be of the order of 15–20 years. A strategy for the procurement and replacement of Sentinel satellites over this period is being elaborated.

The current phase of the GMES Space Component includes the following missions and satellites:

**Sentinel-1** (ESA, 2012a) – Synthetic Aperture Radar imaging for :

- monitoring sea ice zones and the Arctic and Antarctic environments;
- surveillance of marine environment;
- monitoring land surface motion risks;
- mapping of land surfaces: forest, water and soil, agriculture; and
- mapping in support of humanitarian aid in crisis situations.

**Sentinel-2** (ESA, 2012b) – Multispectral imaging for:

- land cover, land use and land-use change-detection maps;
- maps of biogeophysical variables such as leaf chlorophyll content, leaf water content and leaf area index;
- risk mapping; and
- acquisition and rapid delivery of images to support disaster relief efforts.

**Sentinel-3** (Drinkwater & Rebhan, 2007; Donlon, 2011) – Altimetry and medium resolution multispectral optical imaging (visible to infrared) in support of GMES Ocean, Atmosphere, Land, Safety, Security and Climate Services including:

- sea surface topography, significant wave height and surface wind speed over the global ocean;
- sea, ice and land surface temperature;
- ocean colour and land surface reflectance; and
- synergy products over land surfaces derived using optical instrument data.

**Sentinel-4, Sentinel-5P and Sentinel-5** (Langen et al., 2007) – Multispectral imaging and profiling for:

- monitoring changes in atmospheric composition at high spatial resolution;
- daily global mapping and regional at high temporal resolution of ozone, NO<sub>2</sub>, SO<sub>2</sub>, formaldehyde and aerosols; and
- daily global mapping of CO and CH<sub>4</sub>.

**Jason-CS** (Continuity of Service; Bonekamp, 2012) – a low-inclination orbit altimetry mission for continuous monitoring of Sea Surface Height (under Phases A–B1).

## 2.2 GMES Space Component Ground Segment

The GSC Ground Segment is composed of the GSC Core Ground Segment and the GSC Collaborative Ground Segment.

The GSC Core Ground Segment, with GSC-funded functions and elements, provides primary access to Sentinel mission data and coordinates access to Contributing Mission data. It includes the Sentinel Core Ground Segment and the GMES Data Access Layer.

The Sentinel Core Ground Segment comprises:

- The Sentinel Flight Operations Segment (FOS), which provides, for all Sentinels:
  - satellite monitoring and control during all mission phases (i.e. launch and early orbit, commissioning, routine and deorbiting);
  - satellite orbit determination and maintenance; and
  - the network of tracking, telemetry and telecommand S-band ground stations.
- The Sentinel Payload Data Ground Segment (PDGS), which provides, for all Sentinels:
  - planning, acquisition, processing, and dissemination of data products;
  - calibration and validation of Sentinel mission data;
  - user services, including cataloguing, data discovery, metadata access, user help and documentation;
  - systematic reprocessing of historical Sentinel mission data;
  - algorithm and product maintenance and upgrading; and
  - the network of X-band ground stations.

The GMES Data Access Layer provides harmonised access to data from the Sentinel missions and the GMES Contributing Missions.

The GSC Collaborative Ground Segment, with non GSC-funded functions and elements, provides supplementary access to non-ESA and Sentinel mission data, either through specific data acquisition services or specific data products.

In the global GMES framework, Sentinel missions are complemented by other satellites made available by third parties or by ESA and coordinated in the synergistic system through the GMES Data Access Layer (see <http://gmesdata.esa.int>) for all GMES users. This system provides harmonised access to data from the Sentinel missions and the GMES Contributing Missions.

## 2.3 Sentinel Data Policy and Reuse of EO data

An open and free Sentinel data policy has been approved by ESA Member States, endorsed by the European Commission, and finally approved by the EU Parliament and EU Council.

The principles of the Sentinel data policy include:

- anyone will be able to access acquired Sentinel data; in particular, no distinction will be made between public, commercial and scientific uses, or between European and non-European users;
- licenses for the use of Sentinel data will be available free of charge;
- Sentinel data will be made available to users via ‘generic’ online access, free of charge, subject to a user registration process and acceptance of generic terms and conditions;
- additional modes of access to and delivery of additional products will be tailored to the needs of specific users, and thus will be subject to tailored conditions; and
- in the event that security restrictions affect the availability or timelines of Sentinel data, specific operational procedures will be activated.

It is expected that open and free access to Sentinel data (for any purpose, within or outside Europe) will maximise the beneficial use of data for the widest range of applications. It will strengthen EO markets in Europe, in particular in downstream sectors, with a view to enabling economic growth and job creation.

The conditions of access to and reuse of data from GMES Contributing Missions will be determined by the respective mission owners.

## 2.4 Sentinel-3 Development Context

### 2.4.1 International Cooperation

In a recent resolution, the European Space Council (EU, 2010) assigned to ESA responsibility for coordinating the overall GMES Space Component and for the development and procurement of dedicated space infrastructure. As a consequence, ESA is responsible for the development, orbit insertion and commissioning of the Sentinel-3 satellites.

Under a cooperation agreement, ESA and CNES, the French space agency, aim to utilise the expertise already available in Europe to increase the robustness of the satellite Precise Orbit Determination and ensure the performance of the topography mission by embarking a Doppler Orbitography and Radiopositioning Integrated by Satellite (DORIS) instrument on each of the Sentinel-3 satellites. They also intend to take advantage of expertise in the area of altimetry performance and data processing by supporting the definition and validation of the topography-mission-related elements.



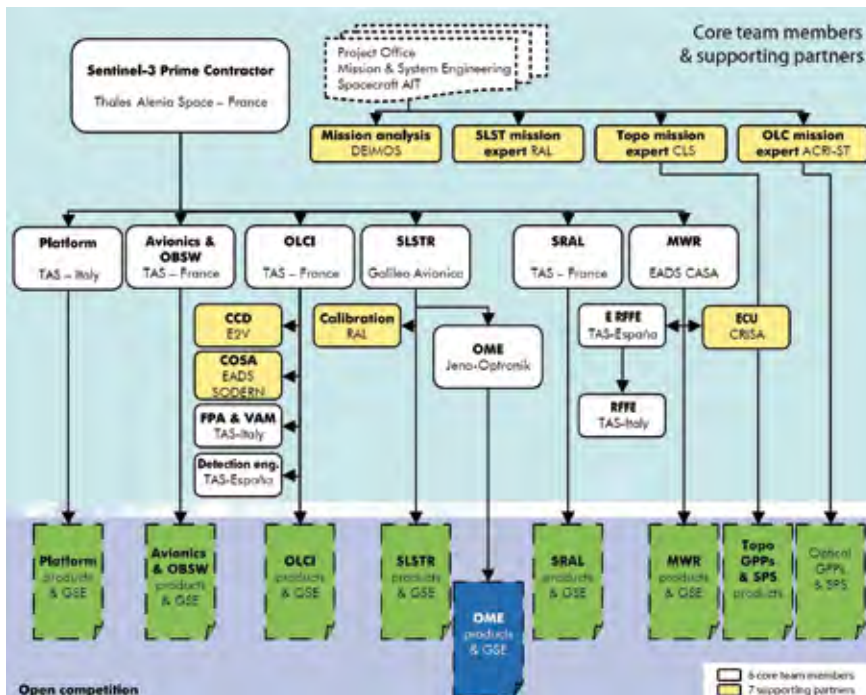

Figure 2.2. The industrial organisation of the Sentinel-3 programme is built around the Prime Contractor, Thales Alenia Space (France). (TAS-F)

In addition to CNES, the Space Council also identified Eumetsat as the proposed operator of the Sentinel-3 (marine) mission, while retaining ESA as interim operator of the Sentinel-3 (land) mission. This decision paved the way for the establishment of a framework agreement between ESA and Eumetsat. This allows Eumetsat to participate in the definition and development phases of the Ground Segment elements required for them to fulfil their role in the operational phase of the programme. In addition, Eumetsat will act as operator of the satellite command and control after completion of the Commissioning Phase performed under ESA's responsibility.

## 2.4.2 Industrial Setup

The industrial organisation of the Sentinel-3 programme (Fig. 2.2) is built around the Prime Contractor, Thales Alenia Space (France). The Prime Contractor is supported by a number of companies (core team members) selected at the start of the programme to provide the most critical elements, based on their past experience in the development of predecessor missions and instruments. The consortium was then completed through an open competition to bring together the best industrial capabilities within the European and EC-FP7 countries participating in the GMES programme.



## 3. Sentinel-3 Mission Requirements

### 3.1 User Requirements

User requirements for the Sentinel-3 mission have been derived from a variety of sources linked to the evolution of GMES services. User requirements and their definition evolve with time; they are formulated in terms of information needs and have to be translated into measurement requirements that are suitable for the development and implementation of a satellite mission. Matching user requirements and measurement capabilities requires the establishment of an interface between system designers, data providers and the user community.

At the programmatic level, the GMES Programme Office and the GMES Advisory Council help to ensure that activities financed by different stakeholders and programmes are managed as efficiently as possible and respond to programmatic and political priorities. At the individual project level, workshops such as GMES Services Element collocation meetings ensure that mechanisms are agreed for the exchange of information and capabilities, such as establishing a common approach to the delivery of services to GMES user organisations identifiable via Service Level Agreements. Table 3.1 summarises the GMES projects that aim to deliver user services exploiting Sentinel-3 data. For a full review of GMES Services and their requirements for Sentinel-3 products and capabilities, see Donlon (2011) and Donlon et al. (2012).

As it is not feasible for Sentinel-3 data to satisfy all user requirements for all services, an order of priorities had to be established. When the foundations of GMES were established, the initial choice of services used to baseline Sentinel-3 requirements (Drinkwater & Rebhan, 2007) was based on three main criteria: availability/maturity, reliability/usefulness and long-term sustainability. As GMES evolved and the Marine, Land, Atmosphere, Safety, Security and Climate Services matured, Sentinel-3 requirements were consolidated. A comprehensive description of Sentinel-3 GMES user communities (Table 3.1) and their requirements can be found in the Sentinel-3 Mission Requirements Traceability Document (MRTD, Donlon, 2011). The Sentinel-3 mission is tailored to serving a wide range of GMES services (see Fig. 3.1) including:

- Numerical Ocean Prediction (NOP) within the GMES Marine Service;
- global coverage land monitoring within the GMES Land Service;
- Numerical Weather Prediction (NWP) within the GMES Atmospheric Service;
- GMES emergency management services;
- GMES security services; and
- GMES climate services.

Table 3.1. GMES services and GMES precursor projects relevant to Sentinel-3 mission requirements.

Type of service	GMES service provider
Marine and coastal environment	EC MCS, GMES MyOcean, GSE MarCoast, PolarView, MARISS, FP6/7 MERSEA, NHMS, MACC, GSE-Coastwatch
Land cover state and changes	EC LMCS, GMES Geoland, Geoland-2, SAFER, G-MOSAIC, GSE-LAND, GSE RESPOND,
Atmospheric pollution management	EC GAS, GMES MACC, GSE-PROMOTE
Risk management (fires and floods)	GMES MACC, SAFER, Geoland, Risk-EOS, RESPOND, GOFC-GOLD
Forest monitoring	Geoland, GSE-FM
Food security	GMES SAFER, GSE-GMFS, EC MARS Food
Emergency services	GMES G-MOSAIC, GSE Risk-EOS, GSE-RESPOND
Maritime security (transport, coastal, ice monitoring)	EC MCS, GMES MyOcean, GSE-MarCoast, GSE-PolarView, FP6/7 MERSEA
Humanitarian aid	SAFER, GSE-RESPOND, FP6 LIMES
Climate and global change issues	National climate centres, including elements of most of the above services

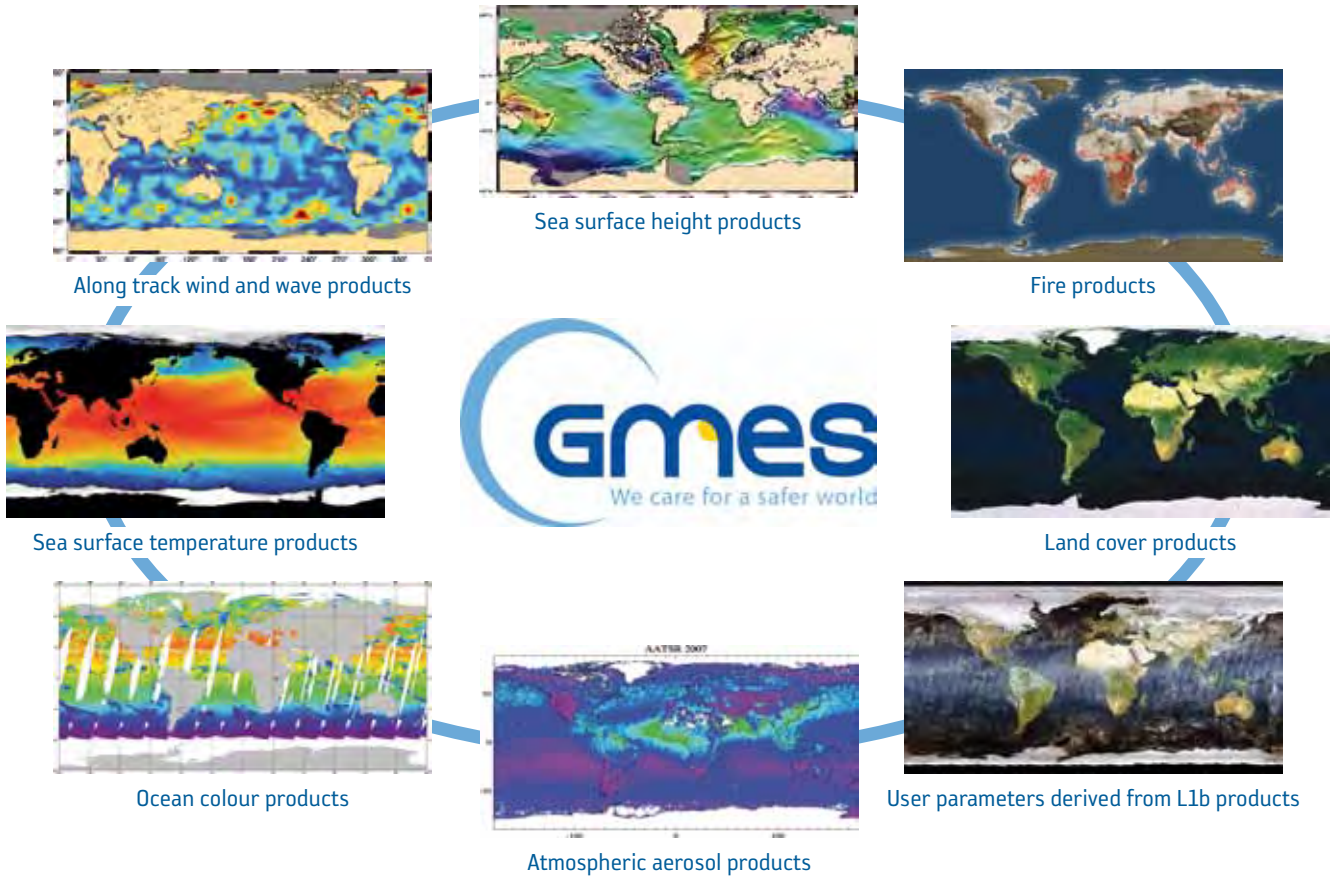

Figure 3.1. Key products required from Sentinel-3 in support of GMES Services. (Credits, clockwise from top left: AVISO; CLS; ESA World Fire Atlas; ESA; GEO; GlobAerosol; MyOcean; Met Office)

### 3.2 Mission Requirements

Sentinel-3 will contribute to various GMES ocean, land, atmospheric, hydrological and cryospheric applications. This section discusses the requirements of each of the most relevant areas of application, and the necessary geophysical parameters to be monitored by the Sentinel-3 system.

Europe’s EO measurement capability has developed significantly since the launch of ERS-1/2 and Envisat. The continuity of Envisat’s measurement capability is particularly important for Numerical Ocean Prediction (NOP) models e.g. the GMES MyOcean system models (Bahurel et al., 2010), and for ocean and climate monitoring applications (Fig. 3.2). The quality of NOP systems depends on the delivery of accurate measurements in a robust and timely manner. Many operational systems run NOP models at agreed synoptic times of 00:00, 06:00, 12:00 and 18:00 UTC, with intermediate model runs between these times. The timeliness requirements mean that observations must be available to the data assimilation system within about 3 h of measurement at the satellite platform.

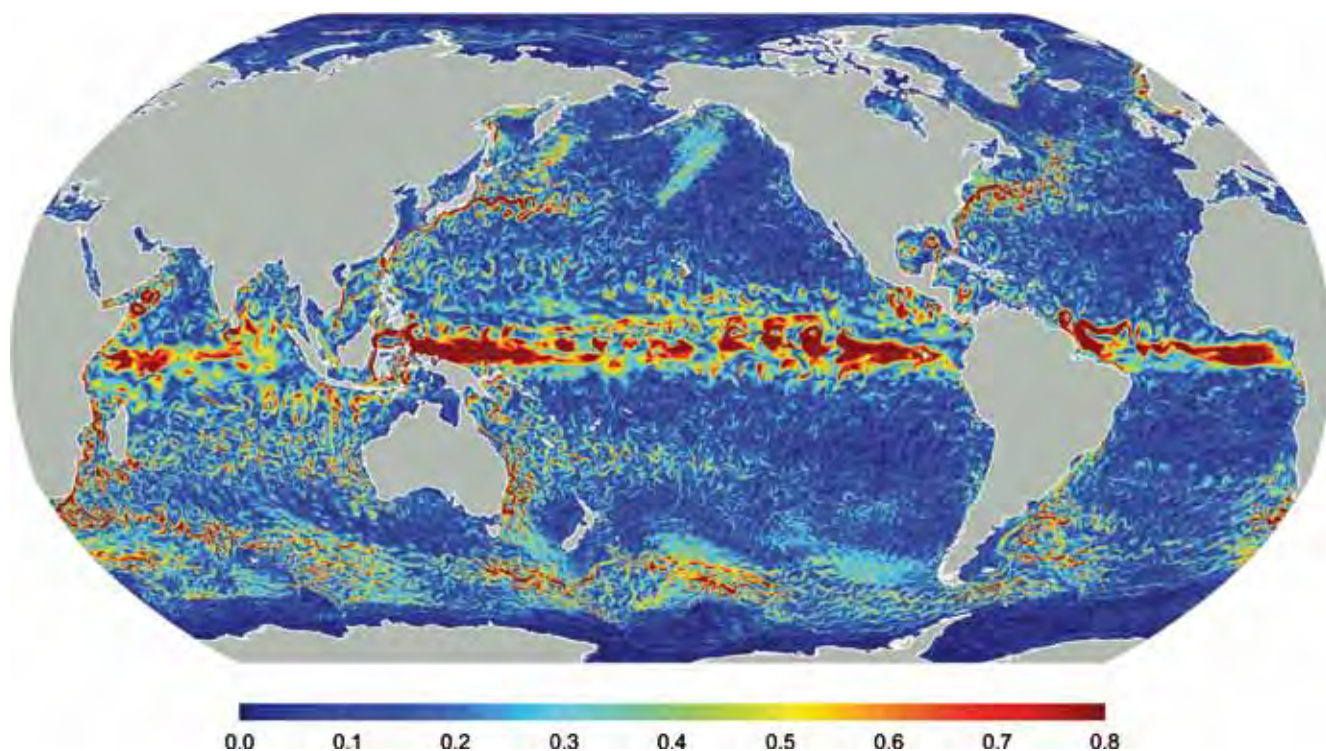

Figure 3.2. Example 6-day forecast of ocean surface currents from the MyOcean/Mercator Ocean 1/12 degree Numerical Ocean Prediction model system ([www.mercator-ocean.fr](http://www.mercator-ocean.fr)). Such forecast products rely on extensive satellite and *in situ* measurement data to initialise and constrain the trajectory of the model system using state-of-the-art data assimilation systems. (Mercator Ocean)

### 3.2.1 Ocean Altimetry Measurements

The field of altimetry has developed steadily since 1985 and the benefits to oceanography and NOP modelling have been outstanding. There has been a semi-continuous series of missions, starting with Geosat (1985), and followed by ERS-1/2 (1991 and 1995) and TOPEX/Poseidon (1992). Such missions continued with the Geosat Follow-On (1998), Jason-1 (2001) and Envisat/RA-2 (2002). At present, only altimeter systems are capable of systematically measuring Sea Surface Heights (SSHs), from which ocean circulation patterns and sea level can be determined on a global scale (Fig. 3.3). Altimeter systems also provide collocated measurements of significant wave heights and scalar wind speeds (at nadir), which are useful in their own right as assimilated or independent validation data products for operational wave forecasting models.

The Global Ocean Observing System “requires global, near-realtime, high accuracy and high resolution observations of sea surface topography” from “at least three (and preferably four) altimeter missions with one very accurate long term altimeter system” (Cotton et al., 2004). In addition, the CryoSat altimeter concept, using synthetic aperture techniques for enhanced along-track resolution, has been recently extended to support operations in coastal waters (both ice-covered and ice-free), and has resulted in significant advances with respect to conventional altimeters.

Such altimeter measurements of SSH will support operational analyses of the structure and variability of global ocean circulation, and will contribute to research aimed at improving understanding of the mesoscale variability of and trends in mean sea level (see Fig. 3.3). Since the spatial and temporal sampling characteristics of an altimeter are largely determined by the satellite orbit, the orbit must be optimised for each planned altimeter-carrying mission in order to be able to resolve dynamic ocean features at different spatial scales.

Figure 3.3. Example products derived from high-inclination altimetry in constellation with low inclination orbit altimeters. *Left:* Mean absolute dynamic topography highlighting the Antarctic circumpolar current that connects all major ocean basins. *Right:* Mean sea level anomalies (i.e. height variations with respect to a mean) in the North Atlantic, highlighting dynamic features such as ocean eddies in the turbulent flow of the Gulf Stream. (AVISO)

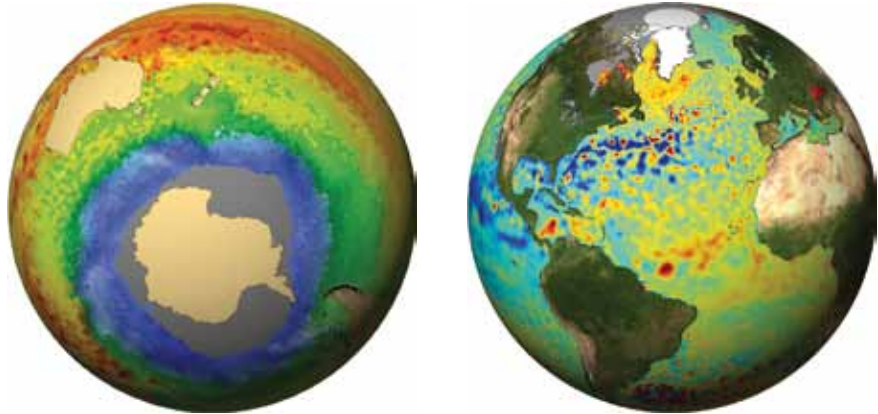

Sentinel-3 is optimised to continue the polar Sun-synchronous orbit of the ERS and Envisat satellites, which is complementary to other operational satellite altimeter orbits (e.g. Jason), providing access to the high-latitude regions.

The principal goal is to use altimeter measurements of SSH to generate global maps that capture the variability in ocean topography at three scales:

- large scale: 100 km resolution maps every 10 days, accurate to 1–2 cm;
- mesoscale: 25 km resolution maps every 7 days, accurate to 2 cm; and
- coastal zones: improved along-track resolution (~250 m) maps every day, accurate to 2–3 cm.

In addition to standard ranging measurements and SSH products, altimeter data can be used to estimate wind speeds and Significant Wave Heights (SWH) using relatively well-understood geophysical inversion algorithms based on the peak backscattered power and the shape of the waveforms. Wind and ocean wave products are of scientific value and of interest in marine forecasting (e.g. wave models), offshore oil and gas platform design and operations, and ship routing. Although the limited spatiotemporal coverage of altimeter wind measurements limits their impact on numerical weather forecasting models, such accurate measurements are extremely useful for providing independent validation of the accuracy of marine wave forecasts. Altimetry products will be of even greater interest and practical value with multi-satellite measurements using scatterometers, combined with *in situ* measurements, providing improved time-space sampling to resolve finer temporal and spatial variability (Figs 3.4 and 3.5).

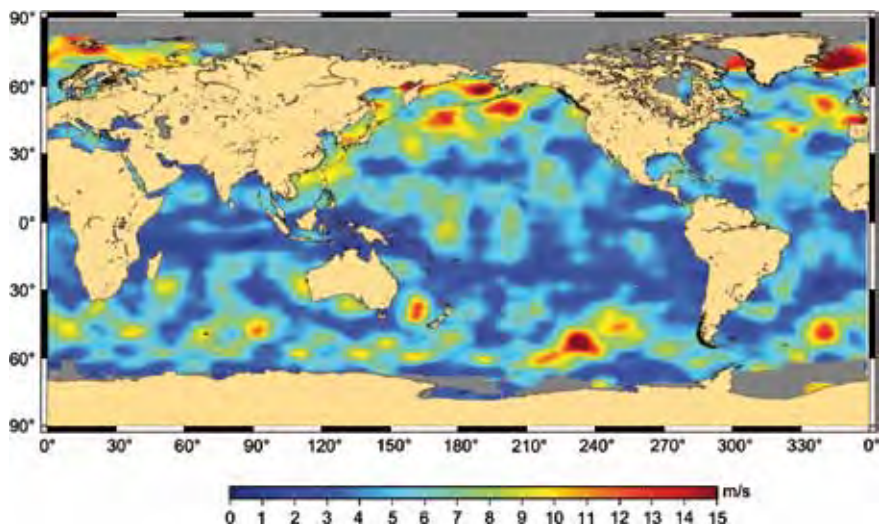

Figure 3.4. Global mean wind speeds derived from multisensor altimetry, showing the North Atlantic storm Joachim on 16 December 2011. (CLS)

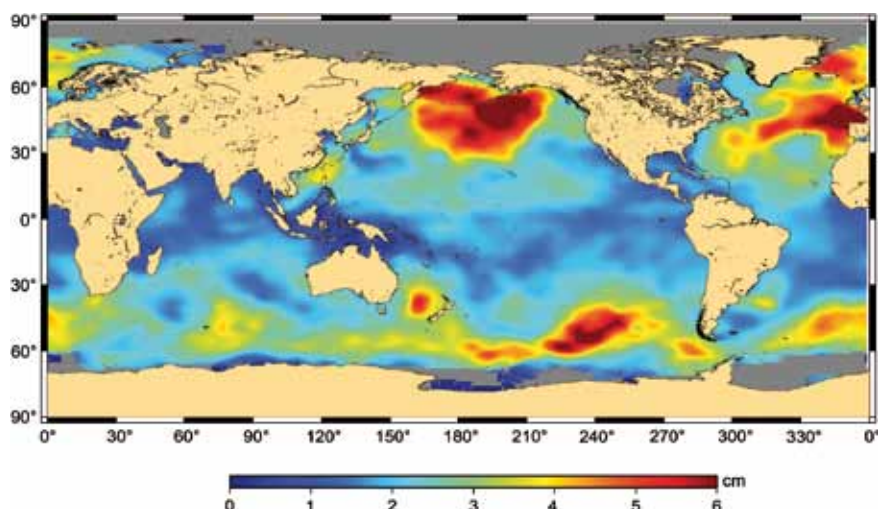

Figure 3.5. Global Significant Wave Heights derived from multisensor altimetry, showing the North Atlantic storm Joachim on 16 December 2011. (CLS)

Table 3.2. Measurement requirements for altimetry specified for 1-Hz averaged along-track samples.

Parameter	Range	NRT delivery	STC delivery
SSH	-	10 cm <sup>a</sup>	3.5 cm
SWH	0.5–20 m	4% (= 8 cm @ 2m)	1% (= 2 cm @ 2 m)
$\sigma^0$	-10 dB $\pm$ 50 dB	$\pm$ 1 dB RMS 0.017 dB s <sup>-1</sup>	$\pm$ 0.5 dB RMS 0.017 dB s <sup>-1</sup>
Wind speed	0–20 m s <sup>-1</sup>	stability <sup>b</sup> 2 m s <sup>-1</sup>	stability <sup>b</sup> 1.5 m s <sup>-1</sup>
Along-track sampling	-	<10 km open ocean <300 m over sea ice and in coastal zones	<1 km open ocean <300 m over sea ice and in coastal zones
Coverage	-	3–10 days (to be optimised with other altimeter missions)	
Revisit time	-	2–3 days	

<sup>a</sup> Note that sea-state bias remains a significant source of uncertainty that is instrument/frequency dependent. This could influence any decision to change from the more traditional heritage Ku-band altimetry of the previous missions.  
<sup>b</sup> Stability computed using averages over 30 s intervals.

The altimeter on Sentinel-3 will contribute to improved SSH wind and wave sampling, particularly in the coastal zone, using synthetic aperture capability.

The high-inclination orbit of Sentinel-3 will bring the added benefit of routine altimetric observations of marine and land ice in the Arctic and Antarctic high-latitude regions. Sentinel-3 will provide continuity to the high-resolution along-track marine and land ice surface measurements of CryoSat, and the ability to derive sea ice thickness and ice sheet topography from elevation profiles.

Table 3.2 summarises the parameters to be derived from the SRAL instrument, together with the expected error budgets.

### 3.2.2 Sea Surface Temperature

Since the late 1970s, Sea Surface Temperature (SST) measurements have been operationally available from the Advanced Very High Resolution Radiometer (AVHRR) imagers flown on NOAA's Thermal and Infrared Observation Satellites (TIROS). Significant improvements in performance were achieved in the early 1990s with the dual-view capability (A)ATSR-class instruments on the ERS satellites, followed by the second-generation instruments on Envisat.

Routine high-quality SST observations derived from polar-orbiting infrared radiometers are also complemented by regional-coverage, high-temporal-

Figure 3.6. Global Sea Surface Temperature map derived from a combination of data derived from the (A)ATSR reference SST satellite instruments, *in situ* measurements and other satellite SST datasets. Sentinel-3 will maintain and extend the high-quality SST measurements of the (A)ATSR series required by GMES and other climate services. (Met Office, UK)

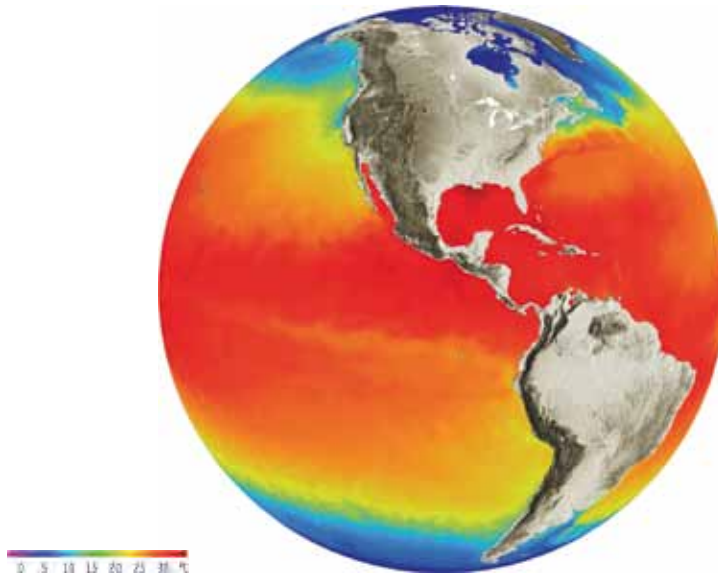

Table 3.3. User requirements for sea and land surface temperature data for various applications.

Application	Temperature accuracy (K)	Spatial resolution (km)	Revisit time
Numerical Weather Prediction	0.2–0.5K	1–50	6–24 h
Climate monitoring, climate stability	0.1K <0.1K/decade (goal)	10–50	8 days
Numerical Ocean Prediction	0.2K	1–10	6–24 h
Coastal/local applications	0.5K	<0.5	1 day
Land surface temperatures	<1K @ 1 km resolution	1 km	Daily
Ice surface temperatures	1K (10%)	<5 km (1 km goal)	Daily
Active fire detection	<3K	0.5–1 km	Daily
Fire monitoring (Fire burned area)	<3K	0.5–1 km	Daily
Lake water surface temperatures	<1K (10%)	<1 km	Daily

frequency SST data from instruments such as the Spinning Enhanced Visible Infrared Imager (SEVIRI) on the Meteosat Second Generation (MSG) geostationary platform, and low-resolution all-weather, global data from the Advanced Microwave Scanning Radiometer (AMSR-E) on Aqua, NASA’s Earth Observing System (EOS) satellite. Although the MetOp series will ensure the continuity of AVHRR data, only (A)ATSR-class measurements approach the accuracy required for climate modelling and climate change prediction/detection (i.e. a high absolute accuracy of <0.3K combined with long-term radiometric stability of 0.1K/decade; see Fig. 3.6). A particular challenge for infrared radiometer measurements of surface temperature is the discrimination of cirrus and other clouds that degrade product performance. A suite of visible and infrared channels is required to minimise the negative impact of clouds.

The required performances of SST measurements for various applications are specified in Table 3.3.

In the ice-covered high-latitude oceans, under clear sky conditions, Ice Surface Temperatures (ISTs) can also be derived from thermal infrared sensors on polar-orbiting satellites such as the AVHRR on MetOp using 10.3–11.3 μm measurements. ISTs are used as surface boundary conditions in climate models and numerical weather forecasting models.



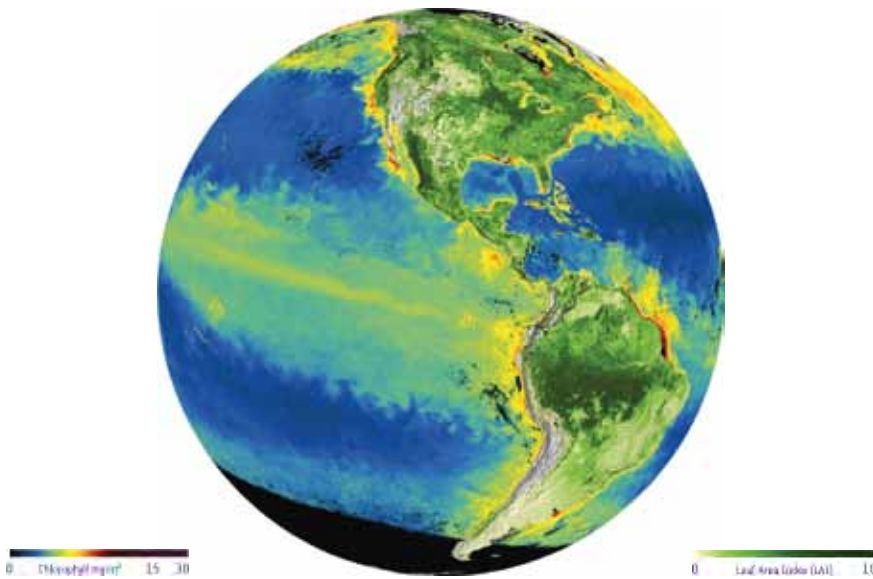

Figure 3.7. Ocean chlorophyll and Leaf Area Index derived from Envisat/MERIS sensor data. Sentinel-3 will maintain and extend the MERIS measurements. (ACRI-ST/CNES/ESA/GeoEye/NASA/VITO)

### 3.2.3 Ocean Colour

Since the success of Coastal Zone Colour Scanner (CZCS), a multichannel scanning radiometer on NASA's Nimbus-7, a number of overlapping missions have focused on ocean colour observations to serve climate research and coastal monitoring. These include the Sea-viewing Wide Field-of-view Sensor (SeaWiFS) on SeaStar, the Modular Optoelectronic Scanner (MOS) on the Indian Remote Sensing Satellite (IRS-P3), the Moderate-resolution Imaging Spectroradiometer (MODIS) on the EOS Aqua and Terra satellites, MERIS on Envisat, and the Visible Infrared Imager Radiometer Suite (VIIRS) on NASA's NPP mission. All of these missions have provided a wealth of valuable data upon which operational services have been built.

A combination of physical ocean data (dynamics) and biological data (colour) has led to new scientific insights with respect to circulation in the upper layer of the ocean, such as the occurrence of algal blooms along internal waves. The underlying processes of photosynthesis and phytoplankton productivity (typically derived by combining ocean colour and SST data) are key inputs to carbon cycle modelling (Fig. 3.7). Furthermore, information on suspended sediments, toxic algal blooms and 'yellow substance' is important for management of coastal zones and inland waters – applications that require sufficient ground resolution.

The Sentinel-3 Ocean and Land Colour Instrument has been designed to:

- improve on Envisat/MERIS observations by mitigating the impact of Sun glint over the ocean;
- have a spatial resolution at a subsatellite point of 1 km over areas of open ocean and sea ice, and of  $\leq 0.3$  km over coastal zones; land products require a resolution of  $\leq 0.3$  km globally;
- include a specific set of channels (identified in Table 6.2) in synergy with the SLSTR instrument;
- provide low-noise-equivalent radiances in all channels;
- have an absolute radiometric accuracy threshold of 2–5%;
- have a relative radiometric accuracy goal of 0.2%;
- include a precise internal calibration system;
- have an adequate dynamic range to accommodate both low oceanic signals in the case of a clear atmosphere and higher signals in the presence of relatively high aerosol loading (optimised for ocean colour measurements);
- ensure a geolocation precision of better than 0.5 pixels; and
- have known polarisation errors of less than 1% for VIS channels.

### 3.2.4 Land Measurement Priorities

The GMES land service project Geoland-2 provides daily monitoring of the terrestrial environment (Pacholczyk, 2011) in support of a variety of European policies and regulations covering water, soil and terrestrial pollution. Geoland-2 services include routine mapping of land cover and land cover change (see Fig. 3.8), global land productivity, surface porosity, forestry, agriculture, water, wetlands and vegetation status, as well as the determination of biophysical vegetation parameters.

The scales addressed in the land surface components of General Circulation Models (GCMs), NWP or forecasting models range from ~1 km (regional) to 100 km (global). Key parameters include surface albedo, surface roughness, resistance to heat exchange (sensible and latent), active fires, burned areas, lakes and rivers, and surface temperatures, as well as land cover characteristics and variability. Since the seasonal and long-term variations in these variables are related to vegetation dynamics, the capability to identify physical land cover characteristics is important for GMES and EU policy makers. GMES services require sustained access to land reflectance measurements and derived vegetation/biophysical products (e.g. land use and land cover maps, Leaf Area Index (LAI), Fraction of Absorbed Photosynthetically Active Radiation (FAPAR), crop monitoring and food security, agro-environmental indicators, forestry management and dynamics, snow extent, water resources) at a moderate spatial resolution (~10–1000 m) with a ~2 day global coverage.

On land, soil and canopy temperatures are among the main determinants of the rate of growth of vegetation and the start and termination of seasonal growth. Hydrological processes such as evapotranspiration and snow and ice melt are highly sensitive to fluctuations in surface temperature, which is also an important discriminating factor in the classification of land surface types. Thus snow/cloud discrimination and Land Surface Temperature (LST) are fundamental to the delivery of effective land products, especially for the northern hemisphere during the winter season.

In addition to the variables listed above, Ice Surface Temperature (IST) and snow and sea ice extent and albedo are recognised as important variables of secondary priority.

Figure 3.8. Global land vegetation cover map produced from Envisat/MERIS sensor data at 300 m resolution, April 2005 to May 2006.

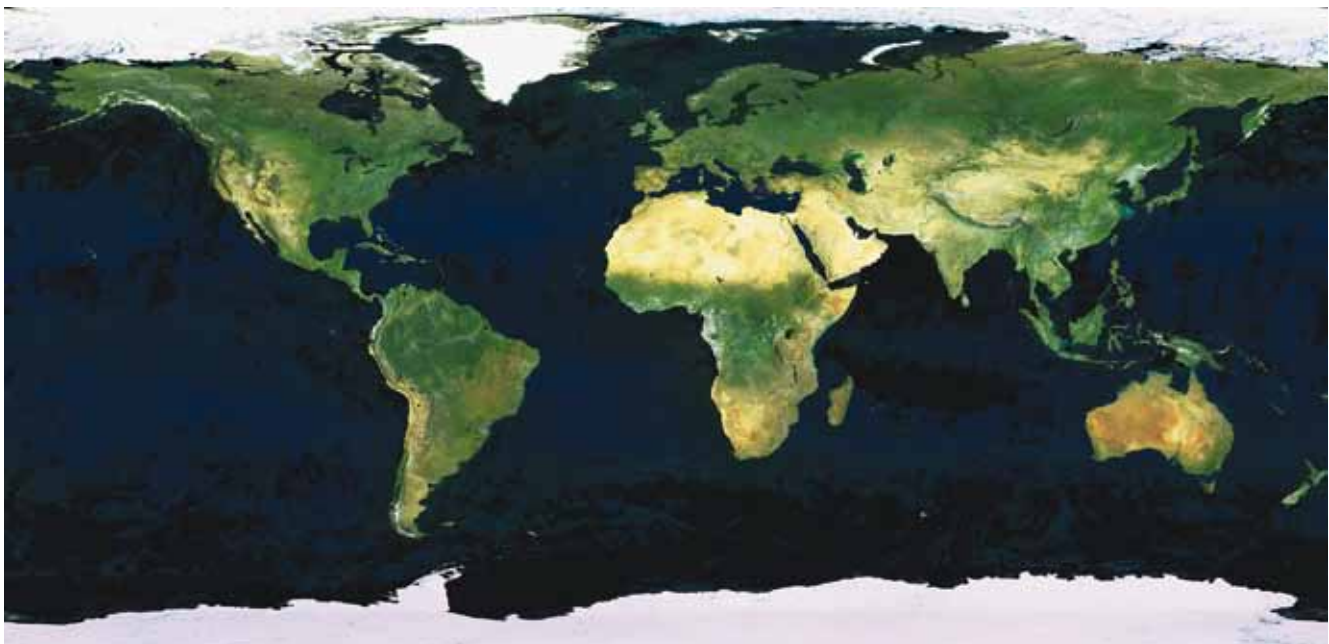

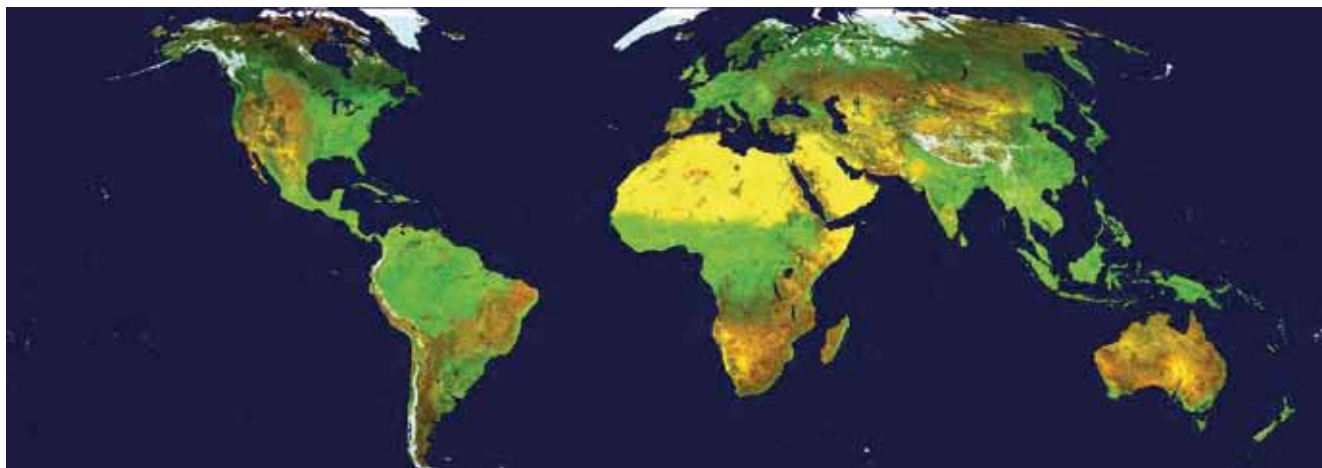

Figure 3.9. Example of 10-day synthesis of vegetation cover data (SPOT, 11 Sept. 2002).

The following GMES-relevant applications that are now operational or close to operational exploitation will require guaranteed access to a variety of parameters:

- vegetation health monitoring, carbon budget assessments and climate modelling (biophysical parameters such as LAI, Fraction of Vegetation Cover (see Fig. 3.9) and FAPAR);
- food security (for crop management, crop yield estimation);
- land cover mapping and change detection (including deforestation and land degradation);
- mapping and monitoring of active fires and burned areas (as inputs to climate change and atmospheric models); and
- surface water resource monitoring (i.e. river and lake levels).

### 3.2.5 Monitoring of Atmospheric Properties

The GMES Monitoring Atmospheric Composition and Climate (MACC) project (GMES-MACC, 2010) is developing services to support institutions that provide advice and warnings related to atmospheric composition. Products derived from Sentinel-3 optical instruments have the widest range of impacts affecting the forcing of climate, air quality, atmospheric visibility and cloud/precipitation processes. Multifrequency L1b radiance data products from infrared and visible measurements are required for use in NWP and re-analysis model runs in NRT together with uncertainty estimates. Altimetry measurements of sea state and surface wind speed over the ocean, atmospheric humidity, atmospheric aerosols, SST, land and lake surface temperatures, vegetation state and coverage, and wild fires are all required for NWP/MACC activities with sub-daily revisit, moderate spatial-resolution (0.3–1 km) and global coverage. As NWP systems assimilate data on 3–6 hourly (typical) cycles, frequent revisit and NRT delivery timeliness requirements are particularly challenging.

Figure 3.10. Examples of products derived from Envisat observations of the ash cloud produced by the Eyjafjöll volcano in Iceland on 19 April 2010. *Top:* MERIS – Aerosol Optical Depth and effective aerosol radius. *Bottom:* AATSR – retrieved parameters from the Oxford–RAL Aerosol and Cloud (ORAC) system. (R. Siddans)

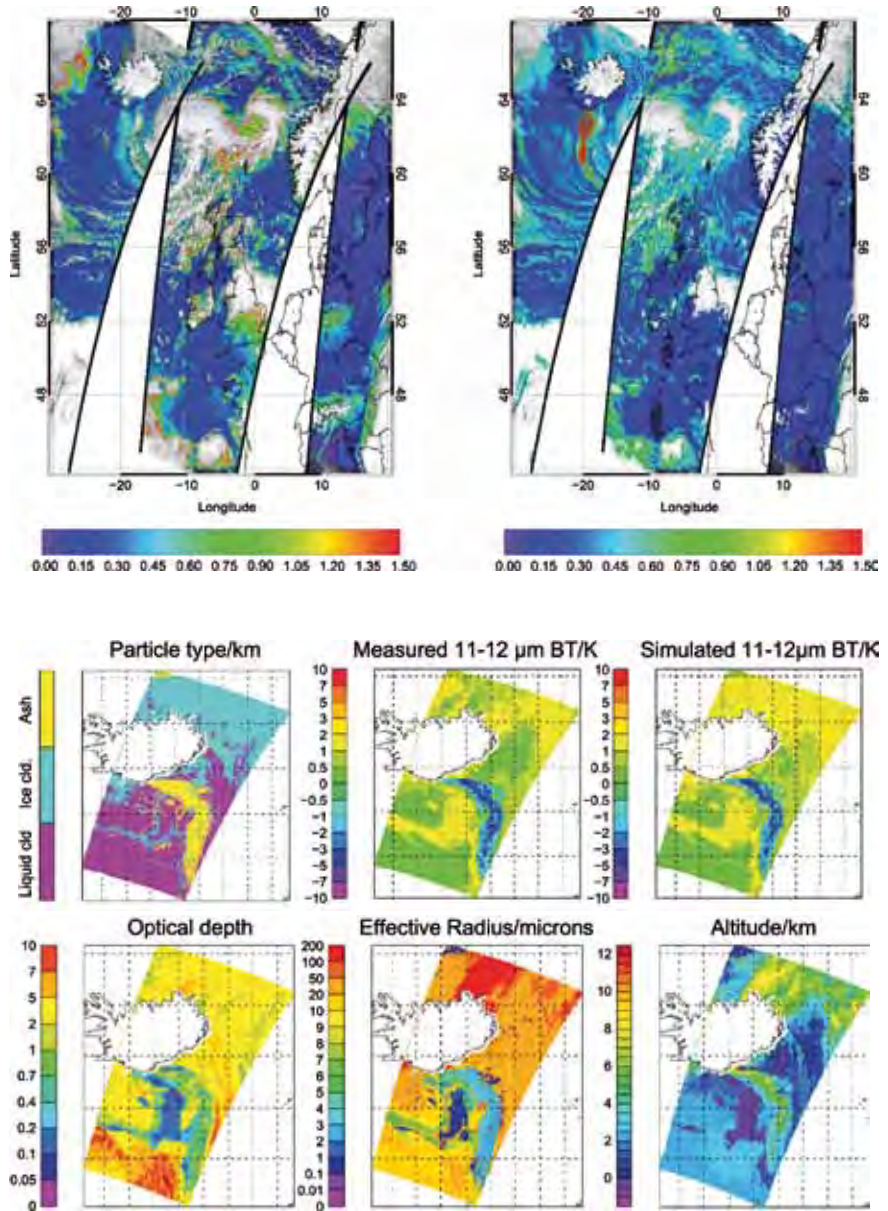

### 3.2.6 River and Lake Level Monitoring

Altimetric gauging of river and lake water levels is a secondary objective of the Sentinel-3 mission, providing innovative estimates of river and lake surface heights to GMES services involved in water resources management and flood risk monitoring. River and lake level monitoring data are also essential for understanding the role of the freshwater cycle in climate. This secondary application requires altimetric elevation estimates of the surfaces of inland water bodies and large rivers. Altimeter tracking has to be sufficiently agile to make valid elevation measurements in the highly variable topography characteristic of river valley terrain, together with high along-track resolution.

### 3.3 Mission Aim and Objectives

Sentinel-3 has been designed to monitor the global environment through measurements that will also be used to constrain and drive global–local numerical prediction models in support of GMES user needs. The aim<sup>1</sup> of the S-3 mission is “to

provide continuity of Envisat type measurement capability in Europe to determine sea, ice and land surface topography, temperature, ocean and land surface radiance/reflectance, and atmospheric measurements with high accuracy, timely delivery and in a sustained operational manner for GMES users” (Donlon, 2011).

Sentinel-3 will continue the legacy of moderate spatial resolution (~300–1000 m) optical measurements (e.g. Envisat/MERIS and (A)ATSR, SPOT/Vegetation

Figure 3.11. Envisat/MERIS image acquired on 11 July 2010 showing a marine plankton bloom that filled much of the Baltic Sea. Such blooms are common in summer, when surface layer plankton are able to feed on nutrients released from the sea floor. Such annual algal blooms impact Baltic fisheries, especially stocks of cod, sprat salmon and herring. Sentinel-3 will provide continuity to Envisat/MERIS observations in support of GMES services.



<sup>1</sup> The aim of a mission is the intended outcome that is desired from the end-to-end mission, with a set of objectives that are directly aligned with the aim.

and MetOp/AVHRR) for marine, atmospheric land services, including generic land cover mapping and biogeophysical parameters. The mission will also provide continuity to the CryoSat-2/SIRAL and Envisat/RA-2 systems by contributing to the global constellation of altimeters used to measure sea state and wind speeds in support of maritime safety, to contribute to studies of ocean circulation and sea level rise, as well as to establish constraints for ocean forecasting systems.

Now that Envisat is no longer operational, and SPOT/Vegetation is expected to reach the end of its operational lifetime in the 2010–14 timeframe, Sentinel-3 is well suited and well timed to ensure the continuity of these missions for GMES.

The specific objectives of the Sentinel-3 mission are presented in Table 3.4.

Sentinel-3 objectives	
Primary objectives	
—	Provide continuity of an Envisat-type ocean measurement capability for GMES Services with a consistent quality, very high level of availability (>95%), high accuracy and reliability and in a sustained operational manner for GMES users, including: <ul style="list-style-type: none"> <li>— ocean, inland sea and coastal zone colour measurements to at least the level of quality of MERIS on Envisat;</li> <li>— Sea Surface Temperature measurements to at least at the level of quality of AATSR on Envisat;</li> <li>— Sea Surface Topography measurements to at least at the level of quality of the Envisat altimetry system, including an along-track SAR capability of CryoSat heritage for improved measurement of quality in coastal zones and over sea ice.</li> </ul>
—	Provide continuity of medium-resolution Envisat-type land measurement capability in Europe to determine land surface temperature and land-surface colour with a consistent quality, very high level of availability (>95%), high accuracy and reliability, and in a sustained operational manner for GMES users.
—	Provide, in a NRT operational and timely manner, L1b visible, shortwave and thermal infrared radiances and L1b/L2 topography products for use by GMES Services with a consistent quality, very high level of availability (>95%), high accuracy and reliability, and in a sustained operational manner for GMES users.
—	Provide, in a NRT operational and timely manner, a generalised suite of high-level <i>primary</i> geophysical products with a consistent quality, very high level of availability (>95%), high accuracy and reliability and in a sustained operational manner for GMES users. Products shall include, as priority: <ul style="list-style-type: none"> <li>— global coverage Sea Surface Topography for oceans and coastal areas;</li> <li>— enhanced-resolution SSH products in the coastal zones and sea ice regions;</li> <li>— global coverage Sea Surface and sea Ice Surface Temperature;</li> <li>— global coverage ocean colour and water quality products;</li> <li>— global coverage ocean surface wind speed measurements;</li> <li>— global coverage Significant Wave Height measurements;</li> <li>— global coverage atmospheric aerosol consistent over land and oceans;</li> <li>— global coverage vegetation products;</li> <li>— global coverage Land Ice/Snow Surface Temperature products; and</li> <li>— ice products (e.g. ice surface topography, extent, concentration).</li> </ul>
Secondary objectives	
—	Provide continuity of medium-resolution SPOT/Vegetation P-like products by providing similar products over land and oceans with a consistent quality, very high level of availability (>95%), high accuracy and reliability and in a sustained operational manner for GMES users.
—	Provide in an operational and timely manner, a generalised suite of high-level <i>secondary</i> geophysical products with a consistent quality, a very high level of availability (>95%), high accuracy and reliability and in a sustained operational manner for GMES users. Products shall include, as priority: <ul style="list-style-type: none"> <li>— global coverage fire monitoring products (burned areas, risk maps, etc.); and</li> <li>— inland water (lakes and rivers) surface height data.</li> </ul>

Table 3.4. Primary and secondary objectives of the Sentinel-3 mission (Drinkwater & Rebhan, 2007; Donlon, 2011)

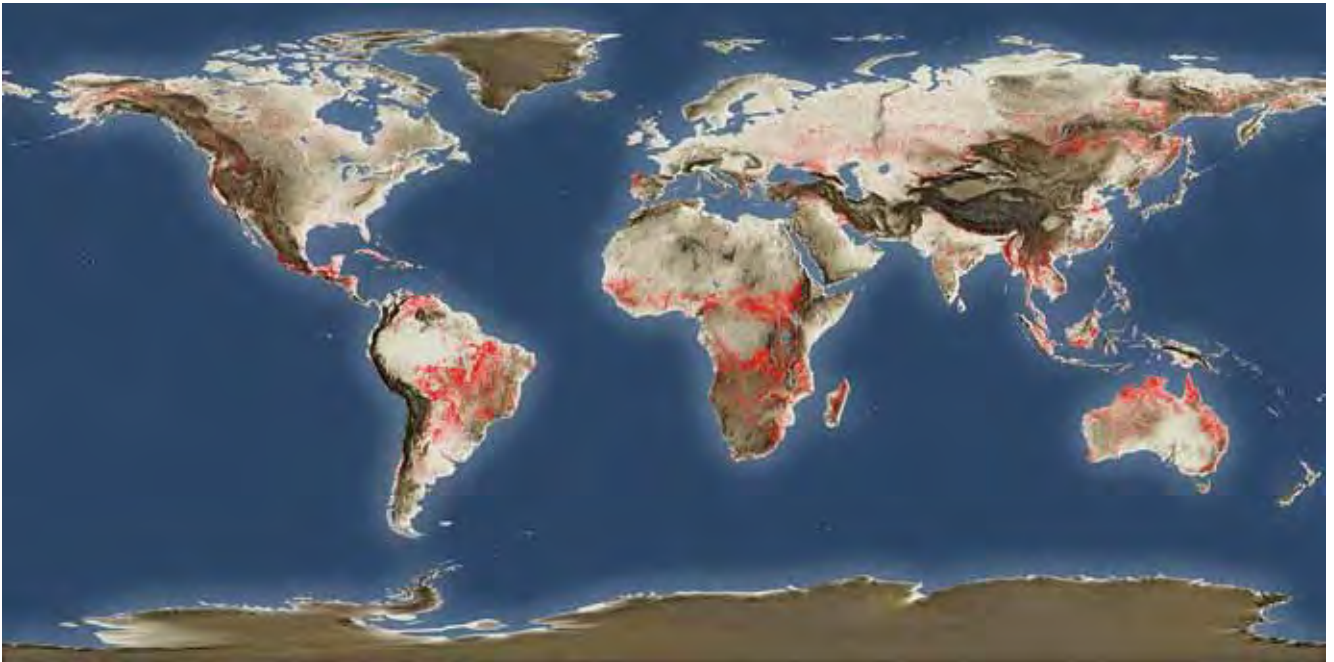

Figure 3.12. Distribution of fire hotspots derived from the (A)ATSR instruments (ESA ATSR World Fire Atlas). Sentinel-3 will provide an enhanced fire-monitoring capability compared to AATSR.

### 3.4 Timeliness

Timeliness refers to the time between data acquisition and the delivery of products to users. The Sentinel-3 mission will acquire data on a continuous basis with high frequency, and make all products available on a near-realtime basis to enable GMES users to meet operational GMES service data assimilation requirements.

Sentinel-3 data will be provided at three levels of timeliness:

- Near-Realtime (NRT) products, made available to the users in less than 3 h after measurement by the satellite instrument;
- Short-Time-Critical (STC) products, made available to the users in less than 48 h after measurement by the satellite instrument; and
- Non-Time-Critical (NTC) products made available within 1 month after measurement by the satellite instrument and archived.





## 4. Sentinel-3 Mission Design

The Sentinel-3 mission has been designed as an operational mission in high-inclination, low-Earth orbit for the provision of data products required by GMES services, as discussed in the previous chapter. The operational character of the mission implies a high level of availability of data products and fast delivery times, both of which have been important drivers in the design the mission. This chapter describes the major technical elements of the satellite and its payload.

### 4.1 Overview

The Sentinel-3 satellite will accommodate a payload of five instruments, all of which have a strong heritage from Envisat:

- the Ocean and Land Colour Instrument, an imaging spectrometer derived from the Envisat MERIS;
- the Sea and Land Surface Temperature Radiometer, derived from the Envisat AATSR;
- the Synthetic Aperture Radar Altimeter, derived from the Envisat and CryoSat Radar Altimeters;
- the Microwave Radiometer; and
- a suite of instruments, including a Global Positioning System receiver (GPSr), a DORIS and a Laser Retro-Reflector (LRR), for Precise Orbit Determination.

To extend the observation capabilities of Sentinel-3, the following improvements have been implemented:

- an along-track SAR mode for the SRAL to observe coastal zones, inland water and sea ice topography with enhanced along-track resolution;
- an ‘open-loop’ altimeter tracking mode for the SRAL to acquire more data over non-flat surfaces (i.e. land, ice sheet margins);
- new spectral channels in the OLCI and SLSTR to allow improved geophysical parameter retrieval and fire detection; and
- full overlap of swaths for the optical instruments allowing a new synergistic product based on the combination of OLCI and SLSTR data (ensuring, among the other things, the continuity of some SPOT/Vegetation products)

### 4.2 Orbit Definition

The launch of the first satellite, Sentinel-3A, is planned for mid-2014, with the launch of Sentinel-3B some 12–18 months later.

The orbit selected has been the result of a trade-off between the constraints imposed by all sensors and operational constraints based on requirements for:

- a short revisit time for the optical instruments, which imposed an orbit subcycle of 4 days;
- a long orbit cycle, implying short spacing between ground tracks, suitable for mesoscale (100–300 km) ocean topography; and
- observations with solar illumination conditions similar to those of Envisat, for mission continuity.

For the S-3 ocean colour mission, a polar Sun-synchronous orbit is required with a Local Time of Descending Node (LTDN) at the equator later than 10:00 a.m. (similar to Envisat) in order to maximise solar elevation (Solar Zenith Angle, SZA > 80°) and to avoid morning haze and cloud. The orbit must also mitigate

the negative impact of Sun-glint on the ocean colour measurements (Kay et al., 2009). The SST mission requires an LTDN earlier than 11:00 a.m. in order to avoid diurnal stratification impacts (Gentemann et al., 2008) and afternoon clouds. In addition, an Envisat repeat orbit is preferred to maintain the continuity of the time series of the Envisat AATSR and MERIS measurements.

The S-3 topography mission, as a single altimeter mission, cannot address these requirements alone, and so must consider other altimeter systems ‘in constellation’ (Escudier & Fellous, 2006; Cotton et al., 2004). Synergy will result in optimal spatial sampling, cross-calibration and referencing, and negligible tidal aliasing altimetry. As the JASON series will ensure altimetry from a low-inclination (66°) reference orbit (Escudier & Fellous, 2006), it is appropriate for S-3 to maintain an Envisat-type high-inclination polar orbit. This choice of orbit will provide optimal SRAL coverage of the ocean and ice surfaces at high latitudes and of the European shelf seas that is fully in line with GMES recommendations (Ryder, 2007).

Considering the above constraints, the selected orbit is polar, Sun-synchronous (98.6° inclination), with a mean altitude of 815 km and a repeat cycle of 27 days (14 + 7/27 revolutions per day). The local time of the equator crossing (LTDN) is 10:00 a.m. (Table 4.1).

In terms of the ocean and land coverage requirements, full mission performance can only be achieved by operating a constellation of two identical satellites. With one satellite, the ground track spacing at the equator would be 2810 km after one day, 750 km after four days, and 104 km after 27 days (Fig. 4.1).

The second satellite will be placed in the same orbit with an offset of 180°, such that its ground track falls exactly in the middle of the ground tracks of the first satellite, thus optimising payload coverage while maintaining a balance between topography and optical mission coverage.

In a two-satellite configuration, after one complete cycle, the inter-track separation will be reduced to 52 km at the equator.

The two S-3 satellites will support full optical imaging of the oceans within two days (even allowing for ocean Sun-glint effects), while delivering global land coverage in just over one day (ignoring reductions in coverage due to clouds) at the equator, with coverage improving with increasing latitude (Table 4.3). The fully overlapping swaths of the SLSTR and OLCI instruments, together with the nadir-pointing SRAL and MWR footprints, are shown schematically in Fig. 4.2.

Table 4.1. Sentinel-3 satellite orbit parameters.

Parameter	Details
Orbit type	Repeating frozen Sun-synchronous orbit
Repeat cycle	27 days (14 + 7/27 per day)
Local solar time	10:00 at descending node
Average altitude	814.5 km
Inclination	98.65°
S-3B satellite	Identical orbit to S-3A but flown 180° out of phase with S-3A

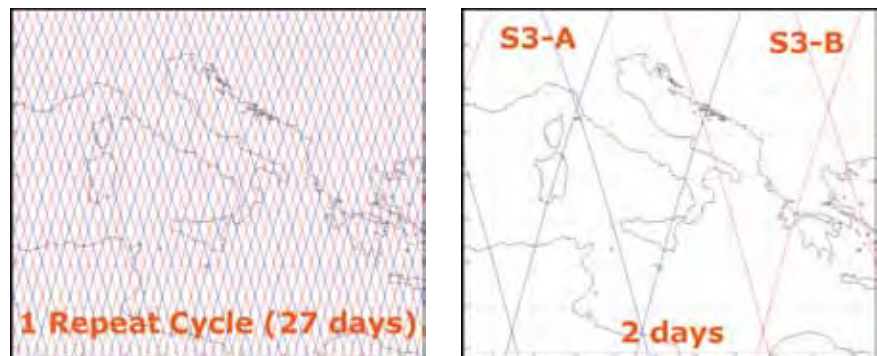

Figure 4.1. Sentinel-3 constellation ground track patterns.

Altimetry mission	Configuration	
Constellation configuration	1 satellite	2 satellites
Main 27-day cycle inter-track separation at the equator	104 km	52 km
4-day subcycle inter-track separation at the equator	Min = 104 km Max = 728 km	Min = 57 km Max = 671 km

Table 4.2. Spatial separation of SRAL ground tracks at the equator.

		Revisit at the equator	Revisit for latitudes >30°	Specification
Ocean colour (Sun-glint free, day only)	1 satellite	<3.8 days	<2.8 days	<2 days
	2 satellites	<1.9 days	<1.4 days	
Land colour (day only)	1 satellite	<2.2 days	<1.8 days	<2 days
	2 satellites	<1.1 day	<0.9 day	
SLSTR dual view (day and night)	1 satellite	<1.8 days	<1.5 days	<4 days
	2 satellites	<0.9 day	<0.8 day	

Table 4.3. Summary of optical instrument revisit times.

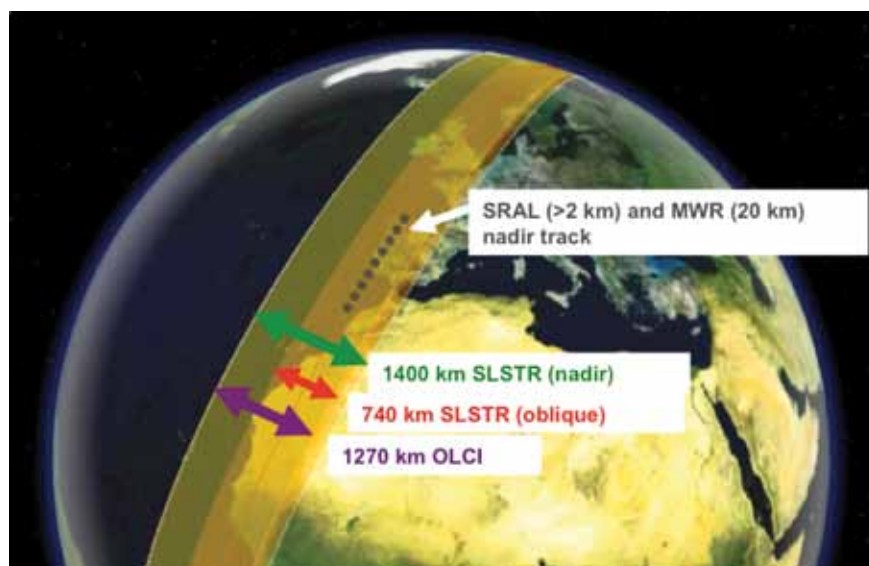

Figure 4.2. Overview of the fully overlapping swaths of the SLSTR and OLCI instruments, together with the nadir-pointing SRAL and MWR footprints.

### 4.3 Satellite Operations

The main characteristics of the Sentinel-3 mission that determine the operations concept can be summarised as:

- each satellite has been designed such that its onboard resources allow for the complete instrument schedule covering the duration of the default mission plan, e.g. 27 days;
- in terms of onboard autonomy, each satellite will be able to operate nominally for at least 72 h without any ground intervention, even in the case of a single onboard failure;
- the satellite will be visible from the primary Telemetry and Telecommand (TTC) station for an average of 10 min during each revolution, except for up to four consecutive blind orbits (every 24 h) during which the ground track will not cross the region visible from the Kiruna ground station; and
- stringent quality of service requirements will ensure that data products are accurate, complete and provided on time. In particular, Sentinel-3 features near-realtime delivery of data within 3 h of sensing.

The satellite routine operation will be highly autonomous and will not require frequent operations from the ground during the nominal mission phases. The Sentinel-3 instruments will be commanded autonomously onboard the satellite on the basis of unchanging geographical data and the selection of observation mode depending on the surface over which the satellite is flying. Changing geographical boundaries, e.g. of sea ice, will be updated only seasonally. This mode of operation is based on predetermined long-term mission plans and will not require a further specific request from a user. All Sentinel-3 payload data collected during one orbit can be acquired via a single ‘dump’ per orbit. It is also foreseen that partial sets of optical data can be downloaded to local users.

As can be seen in Fig. 4.3, the instrument operations are repetitive according to the satellite position, either in its orbit, or with respect to the geographical area being overflown:

- the OLCI sensing domain is a function of the Solar Zenith Angle, i.e. science data will be acquired only when the SZA < 80°;
- the same principle will apply for the visible channels of the SLSTR (channels 1–4);
- the SLSTR IR channels and the MWR will always be acquiring data, and the GPS receiver and DORIS will be in continuous operation; and
- SRAL modes are fixed over specific geographical areas and commanded via the Orbit Position Schedule (see below).

The operation modes for the altimeter SRAL are the classical Low-Resolution Mode (LRM) or the Synthetic Aperture Mode along-track (SAR) with enhanced resolution. The mode is defined by a geographical map located onboard. The LRM mode will be used over the open ocean (300 km offshore) and ice sheet interiors, while the SAR mode will be employed for all other areas. Further, the switching between open- and closed-loop tracking will also be driven by geographical regions (Fig. 4.4).

The GNSS receiver will be operated continuously and autonomously. Only rare immediate execution telecommands will be necessary to command this equipment (parameter update).

Based on the defined mission design and instrument modes, the instrument data rates and relevant data volumes are presented in Table 4.4.

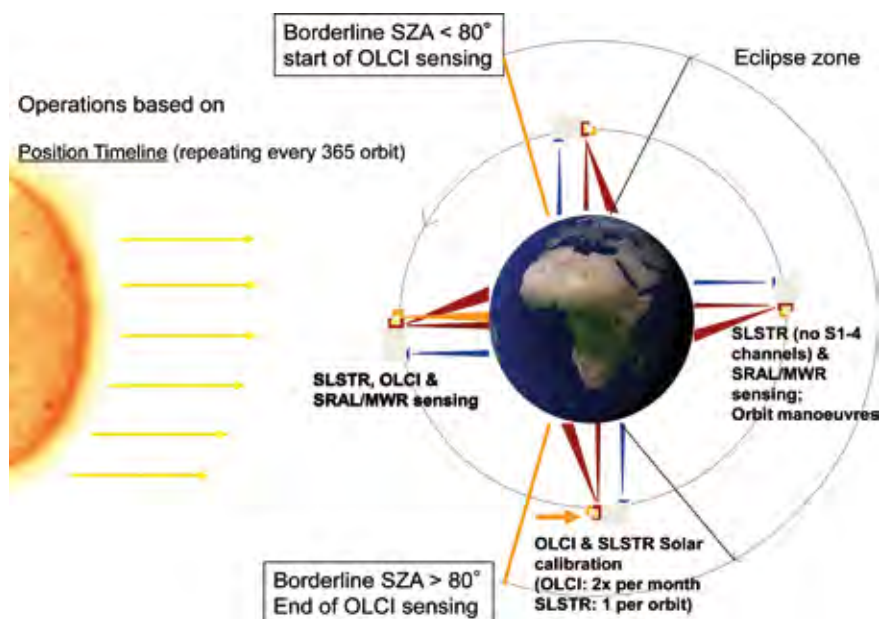

Figure 4.3. Overview of Sentinel-3 operations and payload instrument acquisitions for each orbit. Blue arrows indicate SRAL, red SLSTR and orange OLCI.



Figure 4.4. Baseline SAR/LRM mode map for the SRAL instrument.

Table 4.4. Estimated data rates and volumes.

Instrument/mode	Output rate (Mbit/s)	Duty cycle per orbit	Downloaded data volume (Gbit/orbit)
SRAL/LRM	0.09	Up to 65%	Up to 0.35
SRAL/SAR	10.97	Up to 75%	Up to 50
OLCI	30.5	44%	Up to 81
SLSTR	6.8 (average)	100%	Up to 41
Satellite Management Unit (HKTM, NAVATT, MWR, MWR, GNSS, DORIS)	0.11	100%	0.7
X-band downlink rate			520 Mbit/s



## 5. Sentinel-3 Space Segment

### 5.1 Satellite Configuration

The overall configuration of the Sentinel-3 satellites has been developed primarily to satisfy the needs of the mission, while also complying with the launcher accommodation constraints and the industrial requirements for system integration and testing.

Relative to Envisat, the Sentinel-3 satellites will fly ‘backwards’ with one face (+Z direction) always oriented towards Earth, providing a natural platform to accommodate the payload fields of view (see Fig. 5.1).

Figure 5.2 shows an impression of the satellite in flight with the payload and telecommunications components identified. Figure 5.3 shows the internal elements of the satellite and the general arrangement of the main conical central structure and supporting shear webs, the modular external panels (shown folded out) and related equipment mounting positions. Only the satellite reaction wheels are mounted on the shear webs using dedicated mounting brackets. The hydrazine fuel tank occupies most of the lower-inner part of the central cone and must be available first at the start of satellite integration. Finally, the bottom of the central structure cone is closed with a panel that hosts the satellite thrusters and associated valves. The Sentinel-3 platform design allows for all equipment to be mounted on external panels that together form a box around a primary structure that has been designed to carry large loads during launch.

The main internal structure, shown in Fig. 5.4, consists of a conical tube with four equispaced shear webs that provide stability to the box structure. The satellite launcher interface ring is attached to the bottom section of the main structure cone, providing an optimum load path.

The table-like structure at the top of Fig. 5.4 is the Payload Integration Module (PIM) that hosts both the OLCI and MWR instruments. The SLSTR instrument is located below the PIM and interfaces with the lower part of the satellite called the service module (SM). This payload configuration provides flexibility during satellite integration without a priori sequencing, allowing a more flexible Assembly Integration and Test (AIT) sequence, as well as the independent development and integration of complex payload instruments.

The accommodation of Sentinel-3 within the launcher fairing is shown in Fig. 5.5. A large cone structure forms the mechanical interface between the

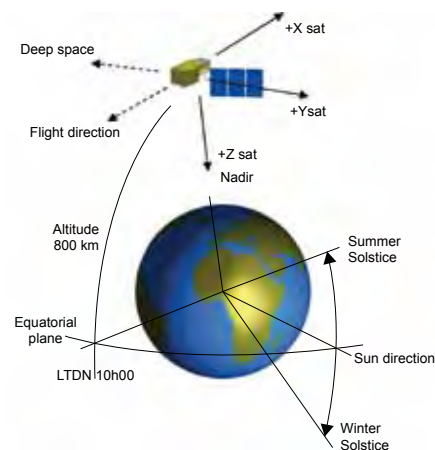

Figure 5.1. Orientation of a Sentinel-3 satellite in orbit. (TAS-F)

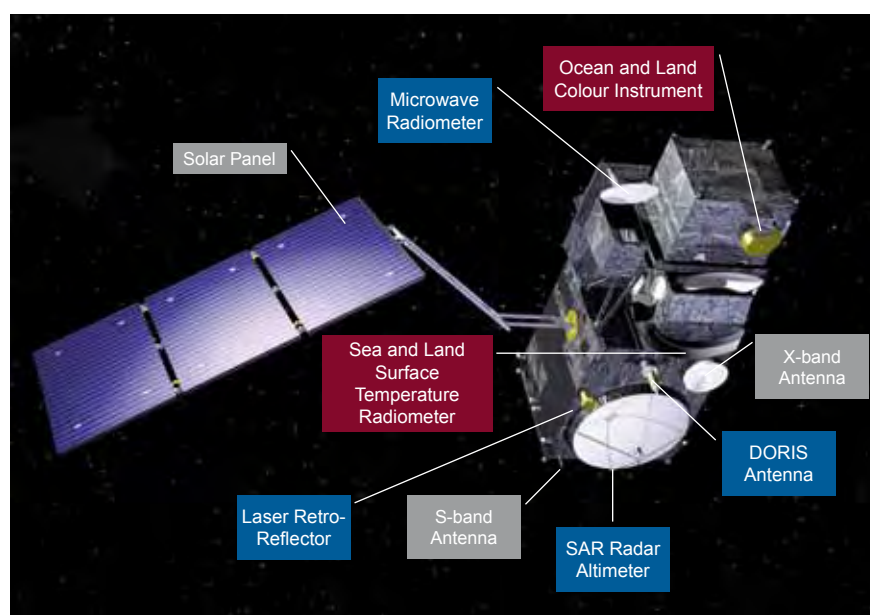

Figure 5.2. Artist's impression of a Sentinel-3 satellite showing the major payload and telecommunications units.

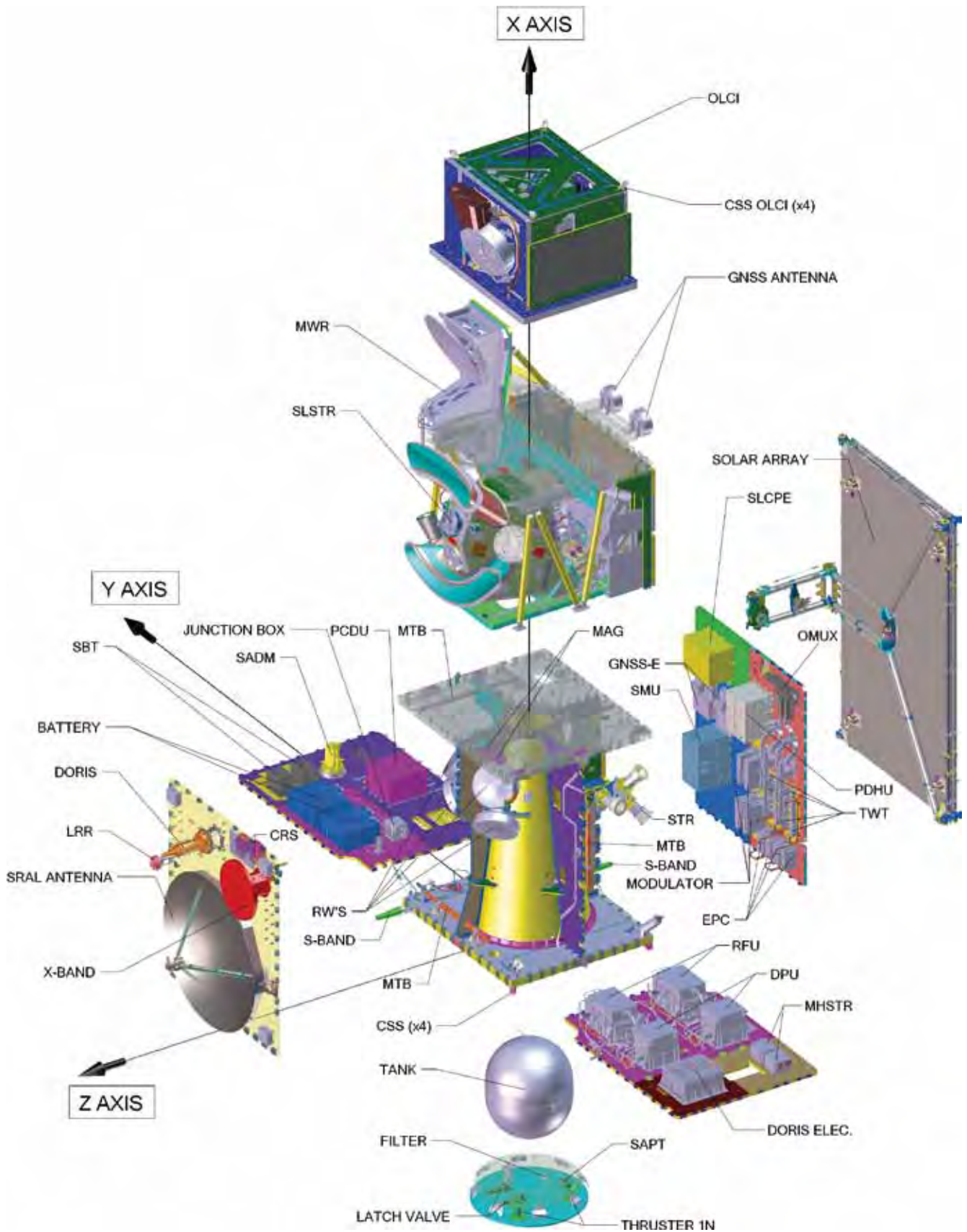

Figure 5.3. Expanded view of the elements of the Sentinel-3 satellite. (TAS-F)



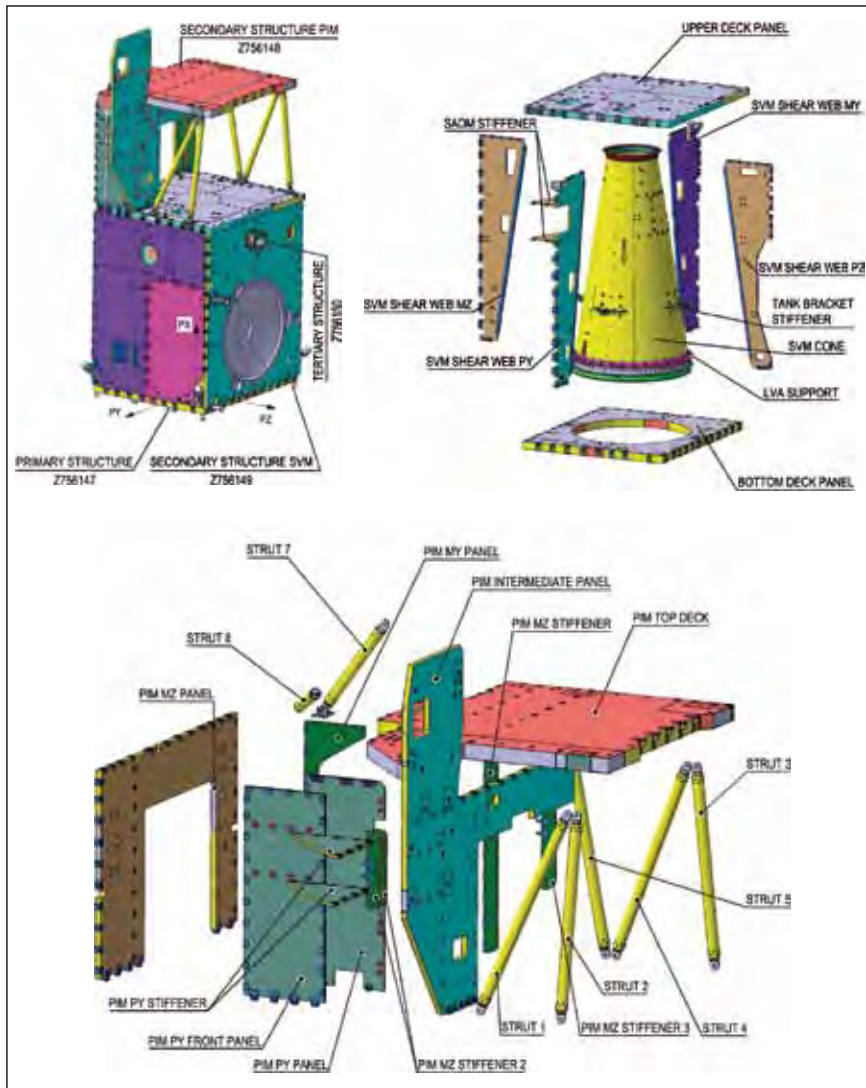

Figure 5.4. Main structural elements of Sentinel-3. (TAS-F)



Figure 5.5. Sentinel-3 in launch configuration inside the Vega (*left*) and Rocket (*right*) launcher fairing. (TAS-F)

launch vehicle and the satellite. Despite the large external payload elements of the Sentinel-3 configuration, the satellite is compact enough to fill the launcher fairing almost entirely, requiring only the solar array wing to be deployed after the satellite separates from the launcher during orbit injection.

## 5.2 Command and Control and Data Handling Architecture

The centralised functional architecture of Sentinel-3 is shown schematically in Fig. 5.6.

The Satellite Management Unit (SMU) provides two mil-1553 buses, discrete standard I/Os and a SpaceWire link to the onboard mass memory (Fig. 5.7). The platform bus is dedicated to command and control traffic between the Attitude and Orbit Control System (AOCS) and the power subsystem equipment, while the payload bus supports packet-oriented traffic between the payload control units and the Payload Data Handling Unit (PDHU). The high-rate scientific data generated by the OLCI, SLSTR, SRAL and MWR are connected via SpaceWire links to the PDHU, which manages data buffering before transmission to the

Figure 5.6. Functional architecture of Sentinel-3. (TAS-F)

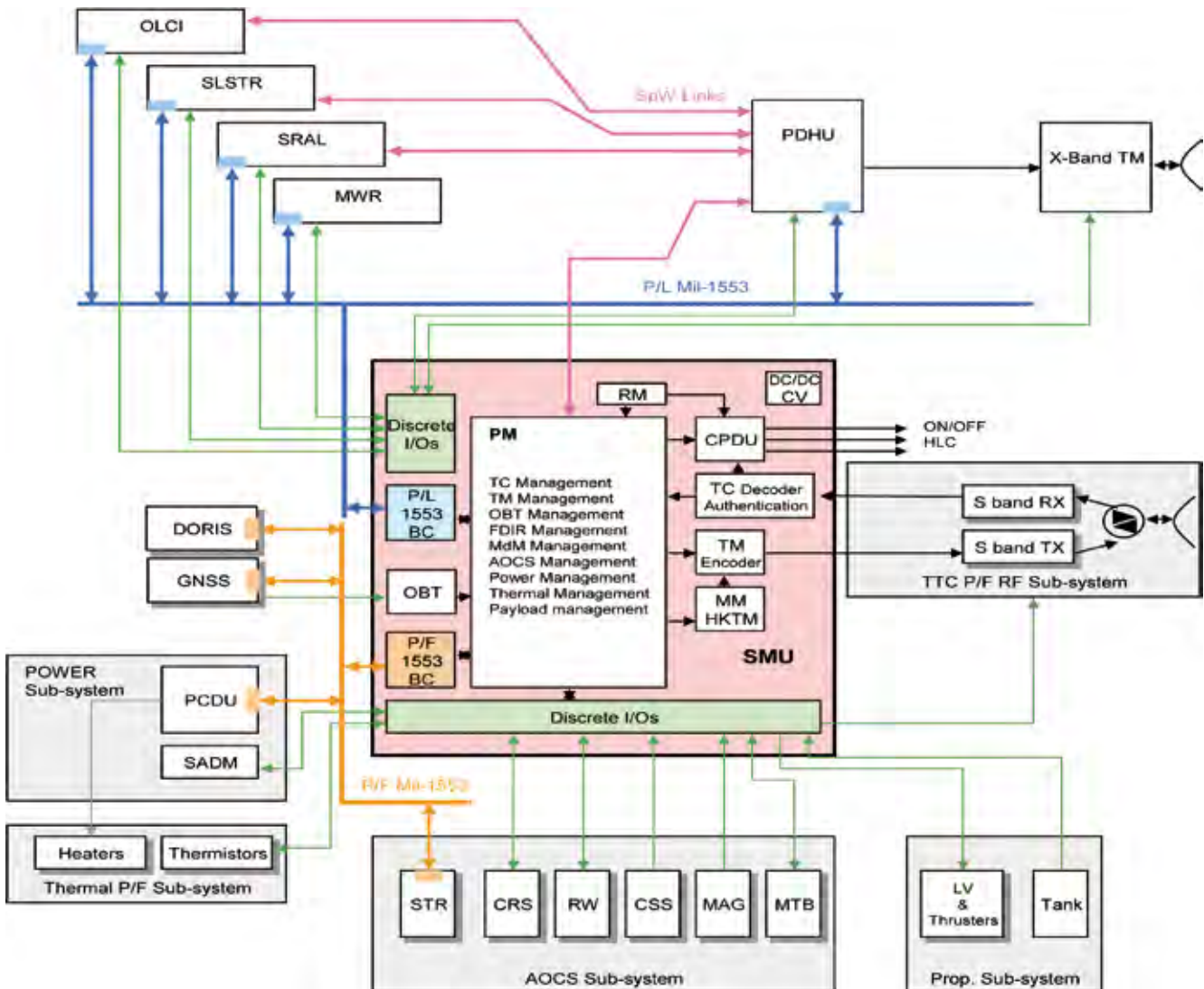

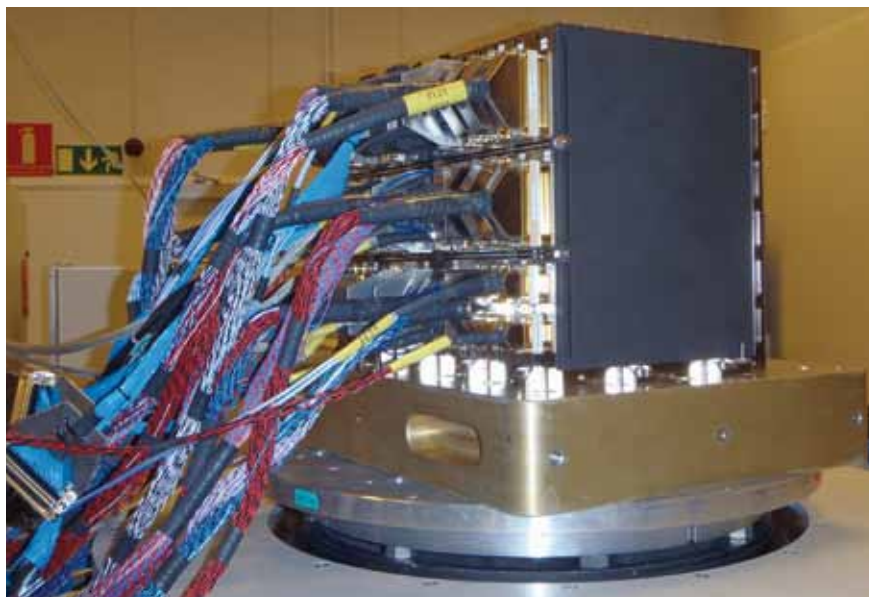

Figure 5.7. The Satellite Management Unit on the shaker, prepared for vibration qualification. (RUAG, Sweden)

ground. In order to include system housekeeping and ancillary data together with the science data, the SMU is linked to the PDHU via a dedicated SpaceWire link, which will also be used to transmit the MWR scientific data transferred from the MWR to the SMU through the 1553 bus. When the satellite is within visibility of an X-band ground station, the PDHU will transmit the data to ground telemetry buffers via a specific interface to the X-band communication subsystem for modulation and RF transmission.

Command and control communications will use an S-band TTC subsystem, connected to the SMU by dedicated digital interfaces. Specific interfaces are implemented to control some of the AOCS sensors and actuators, the solar array drive mechanism and the thrusters, valves and the pressure transducer elements of the propulsion subsystem.

When operating in nominal mode, the SMU will be responsible for the satellite thermal control, acquiring data from numerous thermistors scattered over the satellite and issuing commands to a Power Conditioning and Distribution Unit (PCDU) that switches various heaters on and off. To ensure correlation between the various onboard clocks (satellite and payload), the GPS receiver (GNSS) will send discrete pulses to the SMU, and the SMU will issue pulses to the payload subsystems whose data require accurate time tagging.

The Sentinel-3 command and control architecture is based on standard CCSDS packet telecommand and packet telemetry. Standard services defined by the Packet Utilisation Standard are implemented by the SMU and by onboard intelligent units. Basic services for command verification, housekeeping data telemetry and monitoring (among others) are implemented. In order to prevent malicious access to the satellite, telecommand authentication is implemented. The complete satellite security function is implemented in the hardware. The only way to disclose the secret keys would be physically to remove the cartridge holding them. Security seals are positioned between the SMU and the cartridge to provide visible proof of their integrity.

Figure 5.8 shows a functional block diagram of the Sentinel-3 PDHU. The SLSTR, SRAL and OLCI instruments will use a dedicated bidirectional standard SpaceWire link, while the MWR data will be collected and sent by the SMU together with housekeeping data on another SpaceWire link. Along all of these links, transmission rates can reach 100 Mbit/s.

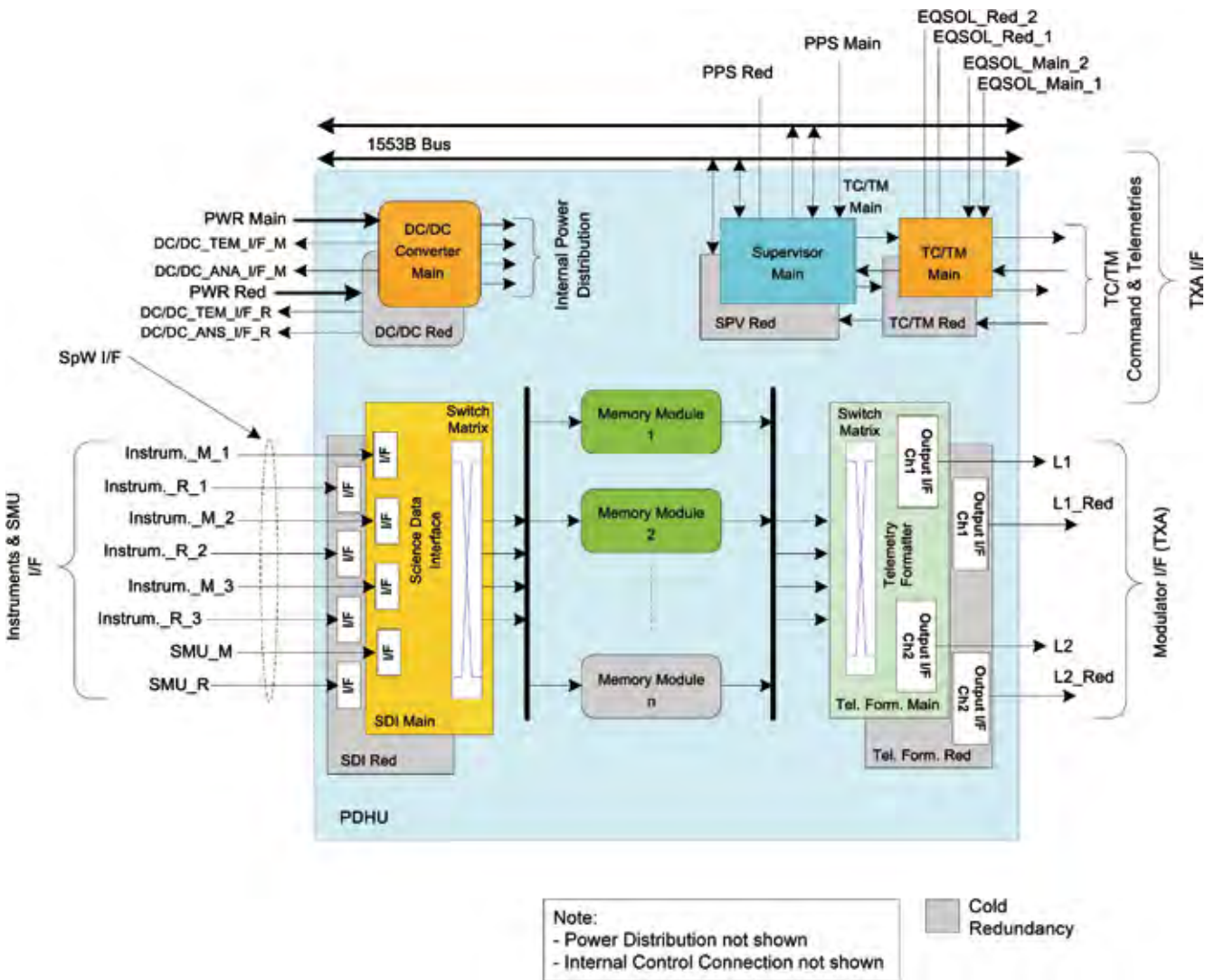

Figure 5.8. Functional block diagram of the Payload Data Handling Unit. (TAS-F)

### 5.2.1 Automation of Operations

Sentinel-3 has been designed as a system that can operate quasi-autonomously in nominal mode for a period of at least two weeks, based on two buffers of commands stored onboard. Operation sequences are defined using both traditional time-tagged commands and commands that are inserted in the position timeline, given as an angle over the orbit and an orbit number within the repeat cycle. Other routine operations will not always occur at the same position but will depend on day-to-night transitions that vary with the season. To accommodate this, a number of orbital events can be predicted onboard, e.g. the entry into/exit from eclipse or the time when the ground will be illuminated by the Sun at a given elevation (conventional day entry). Defining command sequences relative to such events has allowed further automation of mission operations.

This automation does not require any planning from the ground once it is enabled, thus greatly facilitating the routine management and operation of the mission and the continuity of data collection. Such a level of operational autonomy is possible because the onboard GPS receiver provides accurate, realtime knowledge of the satellite position and the absolute time necessary to predict the orbit evolution and the Sun ephemeris.

Accurate and precise knowledge of time is an essential aspect of any space mission. It is required for commanding, either explicitly by the traditional time-tagged TCs, or implicitly when TCs are executed at given orbital positions or with respect to some position of the Sun. A smooth, monotonous Onboard Time (OBT) realised in the SMU and will be used for all commanding and dating tasks. It can be steered to converge towards International Atomic Time (TAI) using the GPS correlation pulse, but will drift in the absence of a usable GPS signal. The dating of scientific data will be measured relative to hardware pulses generated by the SMU. It will therefore be possible to derive absolute dates during post-processing by combining time offsets and the OBT time correlation with respect to TAI.

## 5.2.2 Fault Detection Isolation and Recovery

In order to safeguard the system while maintaining high mission availability, Sentinel-3 will implement a Fault Detection Isolation and Recovery (FDIR) function based on a layered approach to facilitate automated reactions to faults at the lowest possible level in the functional hierarchy (see Table 5.1).

Some equipment will be able to handle problems locally without interventions by the onboard computer or from the ground. Nevertheless, the central onboard system software will handle the core FDIR system using either of two strategies:

- if the fault can be reliably isolated, reconfiguration based on the use of redundant equipment will be made automatically; or
- if the fault cannot be identified without expertise from the ground, a transition to safe mode will be performed to bring the satellite into a secure waiting state. This latter event should be avoided to maximise the availability of operational scientific mission data.

The last level of FDIR will be implemented completely by the hardware, ultimately to protect the system in the event of severe anomalies.

Table 5.1. The hierarchical classification of failures.

	Failure detection level	Failed unit or function	Detection principle
Built-in	0	All	Built-in detection and recovery (reconfiguration or fault masking)
Software detection level	1	Equipment failure Communication interfaces failure	Detected by SW Acquisition of the health status and critical parameters Communication protocol and bus coupler monitoring
	2	Vital satellite function performance anomaly Main function failure	Detected by the Central Software (CSW) Function performance monitoring
Hardware detection level	3	Failure of the processing function of the SMU	Processor module hardware alarm or CSW watchdog
	4	Global satellite malfunction	System alarms

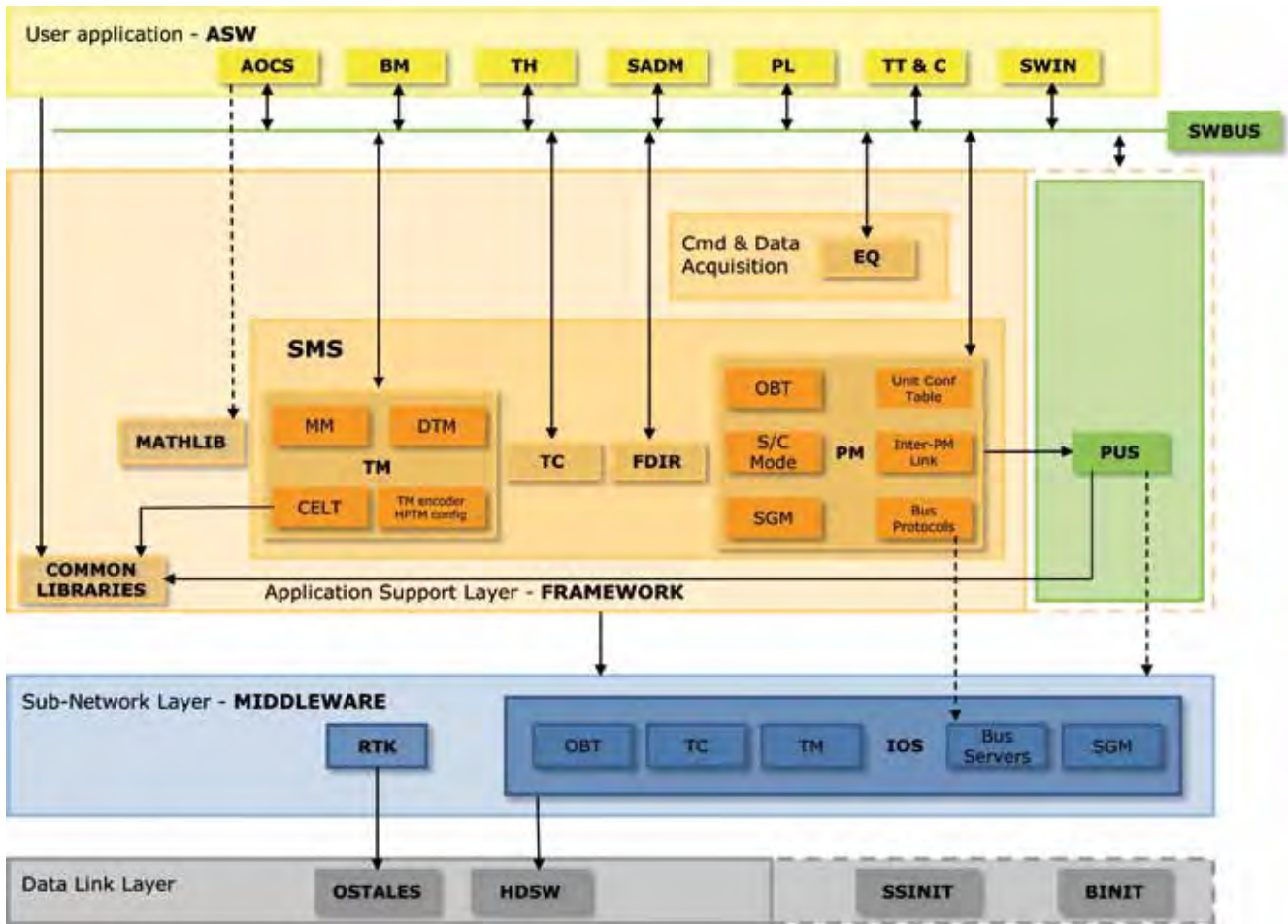

Figure 5.9. Schematic view of the layered architecture of the Central Software. (TAS-F)

### 5.3 Central Software

A major part of the onboard software on Sentinel-3 will be employed to implement all the functionality required by the satellite – mainly for Command and Control, AOCs and FDIR. This Central Software (CSW) will run on the processor module of the SMU and will also be used to support the functionality of other units, in particular the payload instruments and the PDHU. Figure 5.9 presents a schematic view of the static, layered architecture that has facilitated the incremental development and verification approach used to develop the CSW.

The software has been validated using a Software Validation Facility based on a fully simulated SMU including its environment.

### 5.4 Energy and Power Subsystem

The adopted Energy and Power Subsystem (EPS) architecture is based on an unregulated power bus. The bus voltage is the Battery Assembly (BTA) output voltage that increases during charge phases and decreases during discharge phases, and varies between maximum ‘end of charge’ value and a minimum ‘end of discharge’ value.

One Solar Array Wing (SAW), through the Solar Array Drive Mechanism (SADM), will provide the necessary power to the PCDU, which will perform solar array power conditioning and manage the BTA charge. It will supply the bus

users, payloads and thermal control heaters and actuate the devices for the SAW deployment. Figure 5.10 shows a schematic overview of the Sentinel-3 EPS.

To avoid losses and mass penalty of the battery charge and discharge regulators, the PCDU architecture is based on a primary power bus driven by the battery. The bus voltage will vary according to the state of battery charge and will require local regulation by all equipment receiving power. For direct energy transfer on the bus, the PCDU will regulate the current delivered by the solar array by shunting sections of cells. When not in eclipse, the available power will be used to supply equipment in operation and to recharge the battery until the end-of-charge battery voltage is reached. Power will be distributed by the PCDU to various categories of equipment. Essential loads will be powered for the entire mission, from the moment the satellite is activated during the launch sequence, while non-essential loads will be powered according to their operational mode. The PCDU will implement current protection in the distribution arrangement and acquire current telemetry for all power loads (see Fig. 5.11).

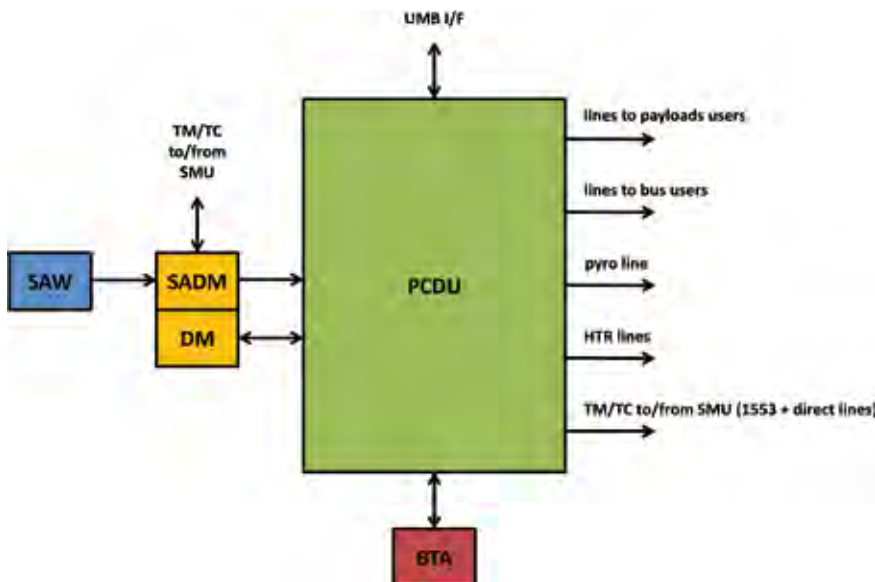

Figure 5.10. Schematic overview of the Energy and Power Subsystem. (TAS-F)

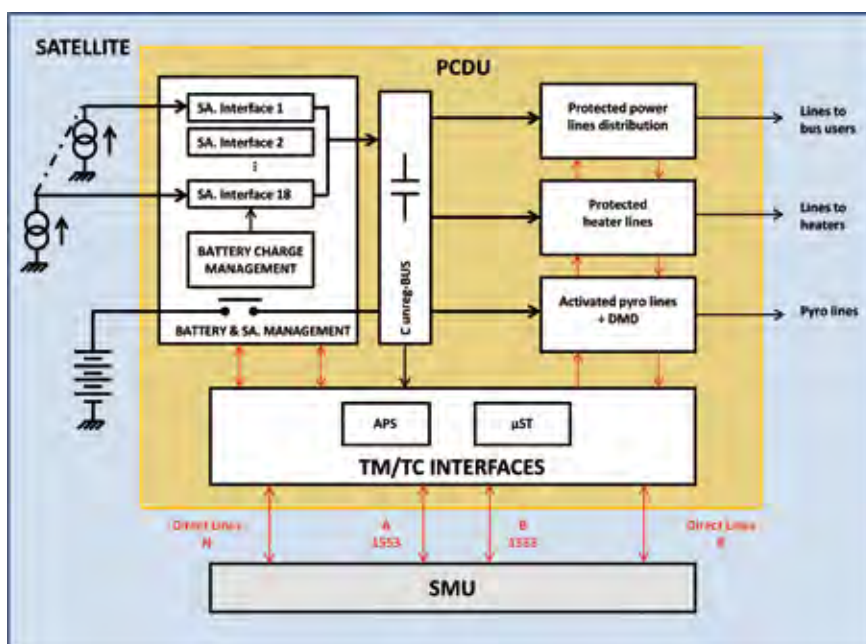
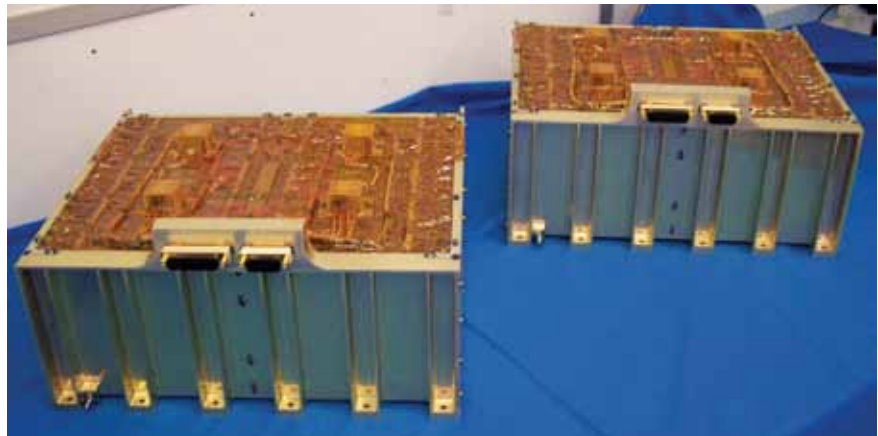

Figure 5.11. Functional diagram of the Power Conditioning and Distribution Unit. (TAS-F)

Figure 5.12. The Solar Array Wing panels.  
(TAS-F)



Figure 5.13. The Li-ion battery modules.  
(ABSL)



The Sentinel-3 SAW panels are shown in Fig. 5.12. The canting angle of the solar wing ( $30^\circ$ ) has been designed to maximise the power generated throughout the year for the mission's 10:00 am descending node Sun-synchronous orbit. Triple-junction GaAs solar cells ( $8 \times 4$  cm, 3G28) are organised in 22 long strings. Three Carbon-Fibre Reinforced Plastic (CFRP) panels host six shunting sections that group together seven strings, providing a total of 2772 cells.

The battery assembly has two identical modules containing series strings of nine state-of-the-art Li-ion cells. Each battery module contains 56 strings in parallel, providing a battery capacity of 168 Ah (Fig. 5.13).

Without considering the payloads that have their own internal harness, the Sentinel-3 platform uses a RF harness to connect antennas by coaxial cables and waveguides and a DC harness for all other interconnections made by wires with standard connectors with backshells. Signals are organised in electromagnetic compatibility classes with their own segregation, sizing, shielding and routing rules. The very high bandwidth required by the SpaceWire signals requires dedicated cables with specific twisting and shielding properties to control the characteristic impedance of the media.



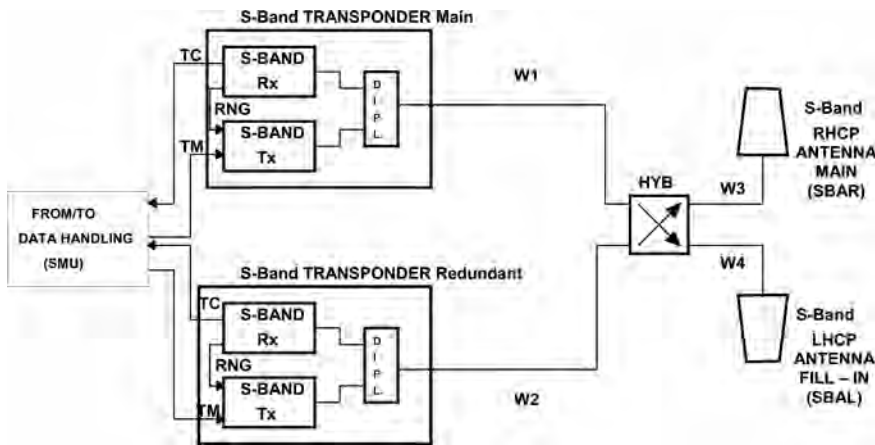

Figure 5.14. Block diagram of the S-band communication subsystem. (TAS-F)

## 5.5 Communications

RF communications with Sentinel-3 will be implemented using two links: a traditional S-band system for command and control traffic, and a high-rate X-band telemetry system that transmits scientific data. Figure 5.14 shows a block diagram of the S-band subsystem.

To support upload of large software elements (typical of modern satellites) the telecommand link has a high 64 kbit/s phase-modulated uplink (SP-L, PM). The S-band downlink provides 1024 Mbit/s in nominal mode (which requires 2048 Mbit/s because of the convolutional encoding) and a lower rate of 128 kbit/s for contingencies. The former is phase-modulated in quadrature (SRRC OQPSK) and the latter is binary phase-modulated (NRZ\_L/SP-L/PM).

The Sentinel-3 payload instruments will generate a high volume of scientific data that will be transmitted to ground using two X-band physical links that together will completely fill the available bandwidth (Fig. 5.15). A block diagram of the X-band Assembly (TXA) and transmission system is shown in Fig. 5.16, and its integration in the Payload Data Handling and Transmission system is shown in Fig. 5.17.



Figure 5.15. The X-band antenna. (TAS-I)

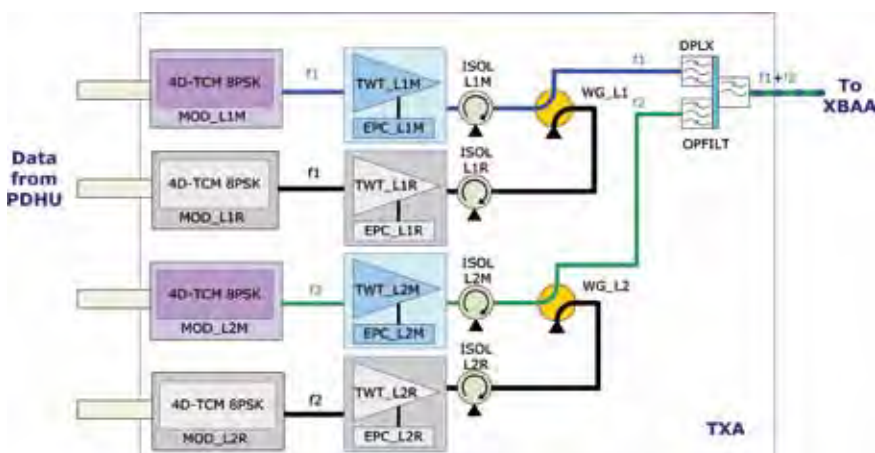
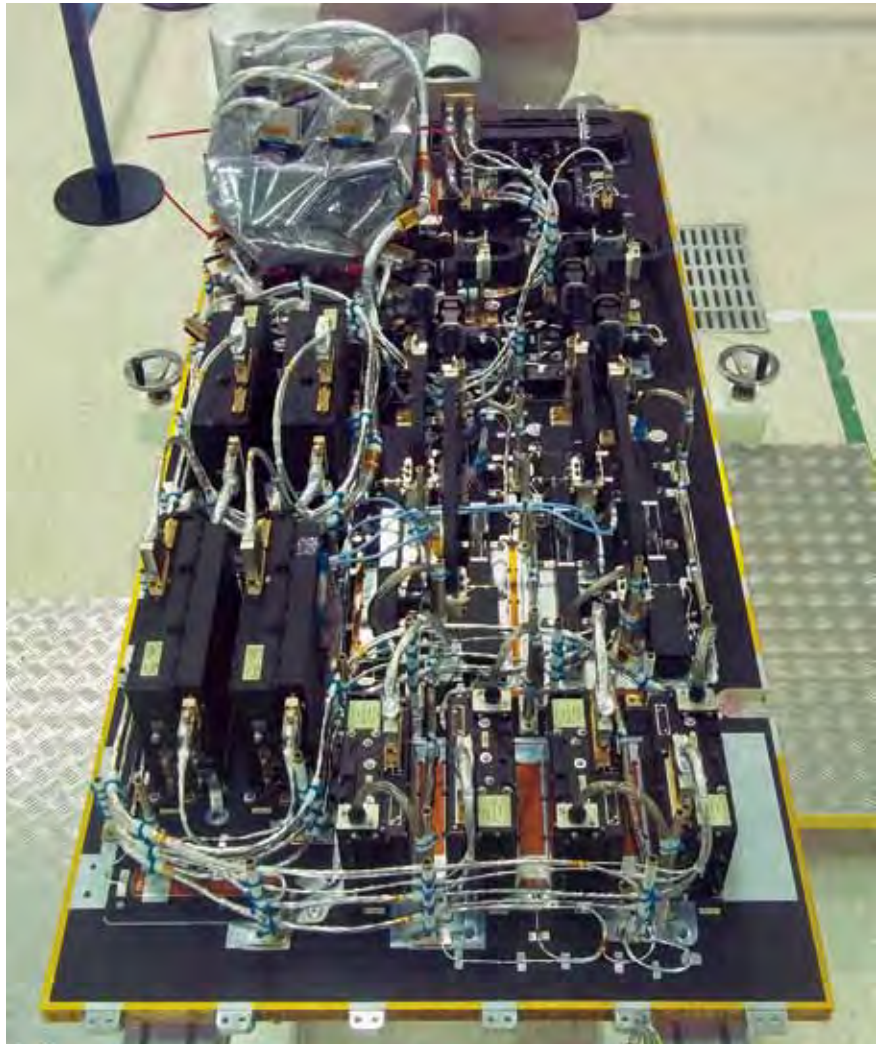

Figure 5.16. Block diagram of the X-band Assembly and transmission system. (TAS-F)

Figure 5.17. Integration of the X-band Assembly and PDHU in the Payload Data Handling and Transmission system. (TAS-I)



## 5.6 Attitude and Orbit Control System and Propulsion

The AOCS will control the attitude and orbit of the satellite, maintaining a thermally safe orientation to collect enough solar energy to allow bidirectional communications with the ground and the correct orientation of the payload instruments according to the mission requirements. Figure 5.18 shows an overview of the AOCS.

A number of sensors are required to estimate the attitude and orbit, and control the satellite. A three-axis, cold-redundant magnetometer will provide the angular rate of the satellite by computing the time derivative of the measured magnetic field vector along the satellite body axis.

The eight corners of the satellite are equipped with coarse Sun sensors. These are simple photodiodes that will allow estimates of the Sun's direction to be computed regardless of the satellite attitude when illuminated by the Sun. The core attitude sensor that will be used during the nominal mission is a fully autonomous three-head StarTracker (Fig. 5.19) that can determine its attitude from any 'lost in space' starting point within a few seconds.

A 24-channel, dual-frequency (L1, L2 codeless), cold redundant GPS receiver will provide core orbit data for both the satellite and its payload. Raw GPS measurements will be sent to the ground for scientific processing. In addition, the GPS receiver will determine onboard and in realtime the satellite's position and velocity in Earth's fixed WGS84 frame, dated in GPS absolute time coherent with TAI onboard. The GPS will use an internal orbit

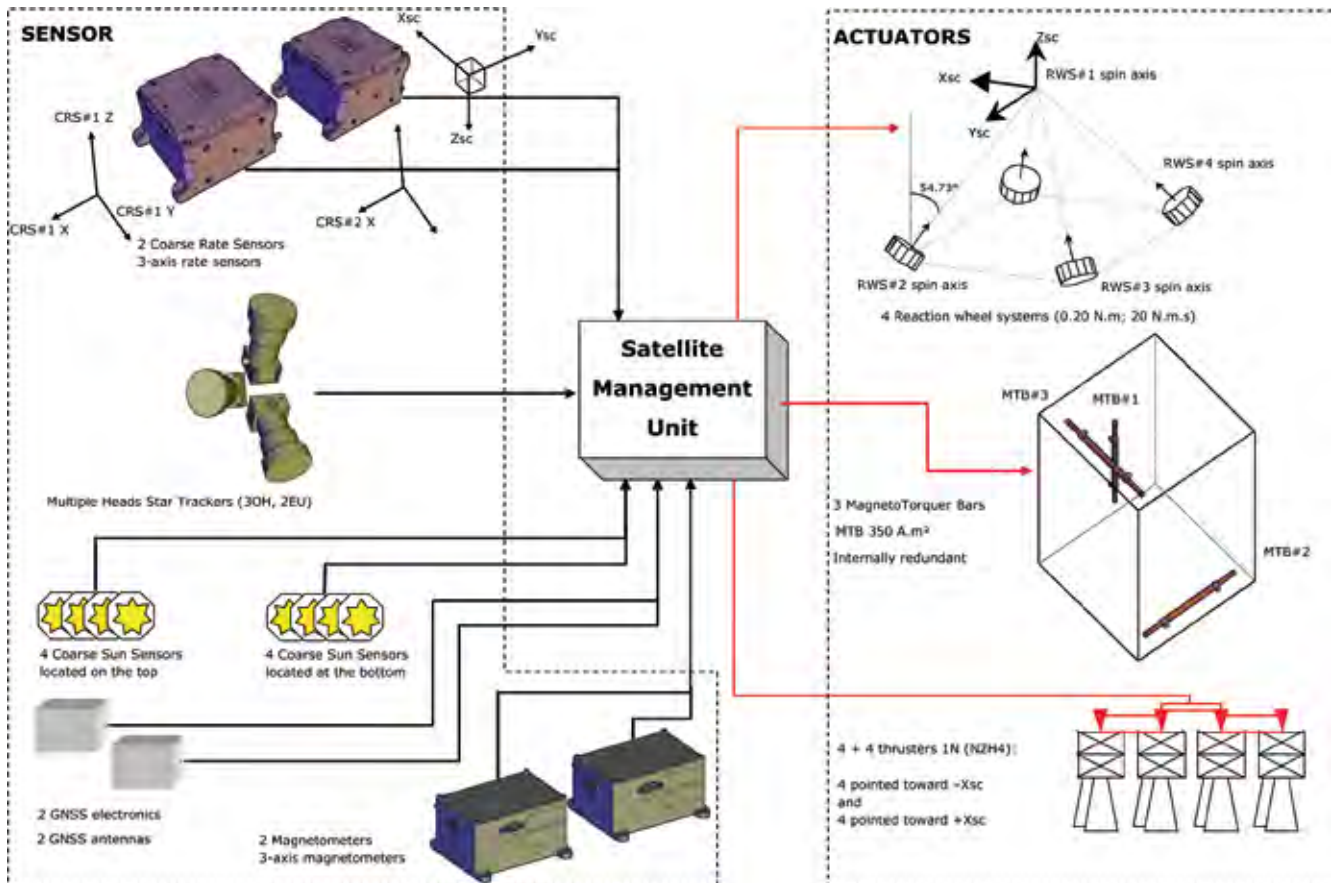

Figure 5.18. The Attitude and Orbit Control system. (TAS-F)



Figure 5.19. The StarTracker. (SODERN)

determination filter to improve its measurement accuracy and to support the open-loop operations of the SRAL instrument (see section 6.3). The GPS filtered solution will also be used by the satellite AOCs for pointing operations after interpolation to increase the sampling rate and improve robustness against missing measurement cycles. The AOCs will further process the position and time measurements to determine Earth's rotation and the Sun ephemeris,

and generate a number of events used for autonomous control of the system. In particular, the AOCS will compute the desired angular position of the Solar Array Wing at a given date (i.e. the Sun's position in the sky) and position over the orbit.

To assist Precise Orbit Determination, the passive Laser Retro-Reflector on Sentinel-3 will support very accurate range measurements from a network of ground stations. In addition, the DORIS instrument will support the onboard GPS receiver, providing a very stable oscillator and a backup for the GPS function in case of failure or outage of the GPS system.

Actuators will be required to control the attitude of the satellite. Traditional cold redundant 300 A m<sup>2</sup> magnetic torque bars will be used to control the satellite attitude and also the momentum of the reaction wheels to avoid their saturation.

Four traditional 20 N m s reaction wheels will control the satellite attitude in nominal operational modes. In the case of failure, three wheels can be used to control the satellite and continue the mission.

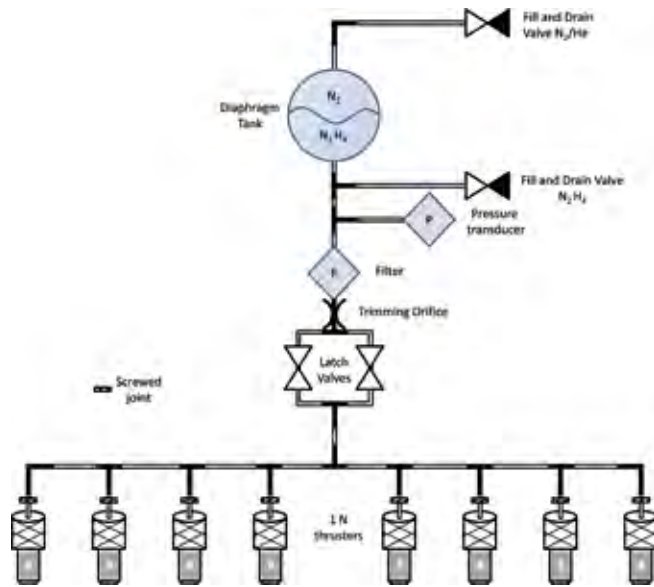

Figure 5.20. Schematic overview of the AOCS propulsion subsystem. (TAS-F)

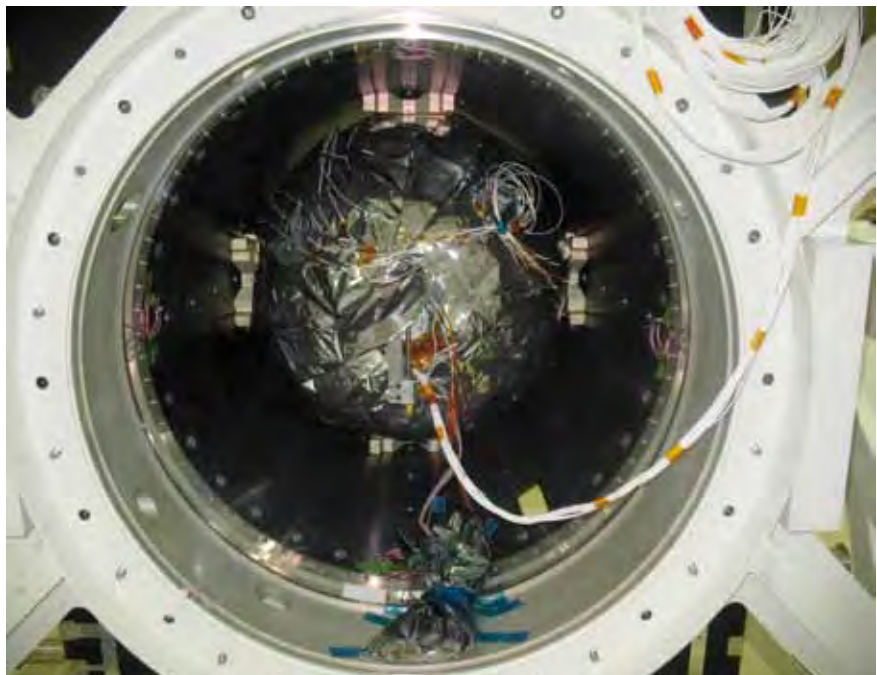

Figure 5.21. Propulsion Tank integration. (TAS-I)

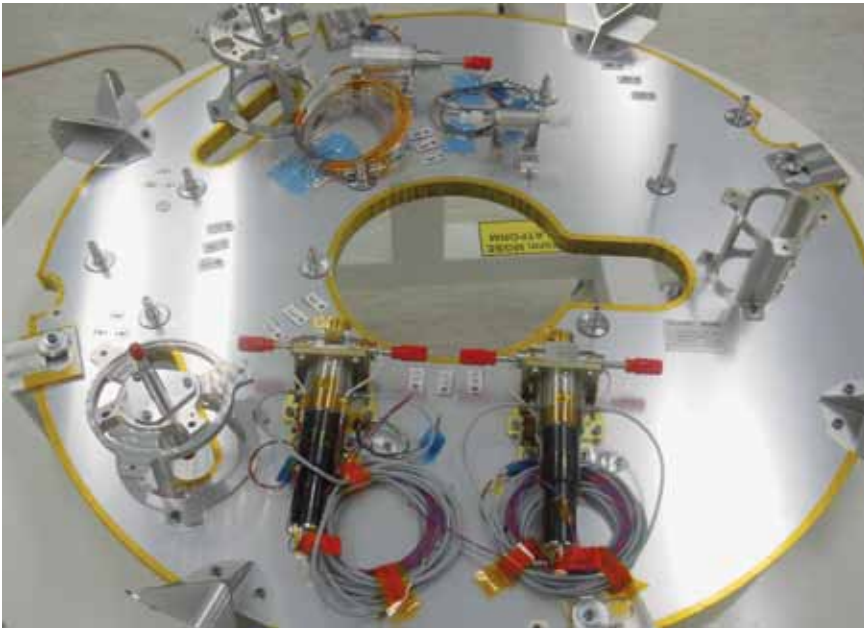

Figure 5.22. Integration of the latch valve into the propulsion panel. (TAS-I)

Periodic corrections to the Sentinel-3 orbit will be required in order to maintain accurate and tightly constrained control of the satellite ground track. Regular (typically every two weeks) but small propulsion impulses will be performed within the orbital plane to account for the natural orbit decay induced by drag. Sporadic (a few times per year) but larger impulses will be performed out of the orbital plane in order to maintain proper inclination and local time at the ascending node.

The AOCS will actuate all corrections using the propulsion subsystem shown schematically in Fig. 5.20.

## 5.7 Mechanical and Thermal Subsystem

### 5.7.1 Thermal Design

Sentinel-3 has been designed to ensure the optimal performance of the payload during nominal operations, during launch and in the event of any contingency, while maintaining every part of the system within a safe temperature range. The key thermal design approach has been to decouple all payload items and all onboard equipment and manage them independently as much as possible. During nominal operation, each payload instrument will be responsible for its own thermal control within the given boundary conditions guaranteed by the system.

Multilayer insulation blankets will be used on all non-radiating surfaces to prevent heat inputs and leakages, as well as to preclude trapping of solar radiation. Black Kapton will be used for the outer surfaces to provide electrical conductivity to avoid surface charging under UV light in space. This design leads to a 'black' satellite.

### 5.7.2 Structural Design

Much of the configuration of the Sentinel-3 structure has been described above. The horizontal floors, the central cone and shear webs that form the backbone of the satellite have been manufactured using aluminium honeycomb and multiple CFRP skins, while the outer panels have aluminium skins in order to provide an effective thermal pathway to radiate away heat (Fig. 5.23).

Figure 5.23. Flight Model of the Sentinel-3 satellite structure. (TAS-I)



Table 5.2. Technical characteristics of Sentinel-3.

Parameter	Value
Maximum mass	1250 kg
Dimensions	3.71 × 2.202 × 2.207 m in stowed configuration
Power	2.1 kW rotary solar wing 10 m <sup>2</sup> GaAs triple-junction solar cells
Battery	Li-ion battery with a capacity of 160 Ah
Average power consumption	1100 W
Launch vehicle	Rockot (S3A)/Vega (S3B)
Mission lifetime	7 years (consumables for 12 years)
Stabilisation	3-axis stabilised using four reaction wheels and three startracker heads
Orbit accuracy	3 m in realtime determination based on GPS and Kalman filtering, 3 cm after processing
Communication links	S-band 64 kbit/s uplink, 1 Mbit/s downlink for command and control 2 X-band 280 Mbit/s downlinks for science data
Onboard memory	384 Gbit solid state mass memory (~170 Gbit of observation data per orbit)
Autonomy	Position timeframe and onboard Sun ephemeris for >2 weeks of nominal autonomous operations

As the main mechanical load path, the launcher interface ring, which will remain on the satellite after separation, is fixed to the base of the central cone with glue and rivets to provide the required high strength and stiffness.

The technical characteristics of the Sentinel-3 satellite are summarised in Table 5.2.

## 6. Sentinel-3 Payload

The following sections describe the functions and technical characteristics of each payload element.

### 6.1 The Sea and Land Surface Temperature Radiometer

The SLSTR is the next generation Along-Track Scanning Radiometer, which has been developed to maintain continuity with the Envisat (A)ATSR series of instruments (Edwards et al., 1990; Llewellyn-Jones et al., 1984). The (A)ATSR provided a reference Sea Surface Temperature dataset for other satellite missions (Donlon et al., 2009), and the SLSTR design is based on the reuse of AATSR concepts with existing and qualified technologies. The SLSTR has been developed to retrieve global coverage sea surface skin temperatures ( $SST_{skin}$ ) with zero bias and an uncertainty of  $\pm 0.3K$  ( $1\sigma$ ) for a  $5 \times 5^\circ$  latitude–longitude area, having a temporal stability of 0.1K/decade. Coppo et al. (2010) provide a comprehensive overview of the Sentinel-3 SLSTR instrument.

Table 6.1 compares the main characteristics and performance of the Sentinel-3 SLSTR, the ERS AATSR and the Envisat AATSR dual-view/along-track scanning instruments, highlighting their steady evolution of capability over time. The operational character of the Sentinel-3 mission and GMES requirements have

Table 6.1. Comparison of the Sentinel-3 SLSTR, AATSR and ATSR-1/2 instruments highlighting the steady evolution of capability and performance.

	Capability	SLSTR	AATSR & ATSR-1 & 2
Swath	Nadir view	>1400 km	500 km
	Dual view	>740 km	500 km
Global coverage revisit times	1 satellite (dual view)	1.9 days (mean)	3 days at mid-latitudes
	2 satellites (dual view)	0.9 day (mean)	–
	1 satellite (nadir view)	1 day (mean)	3 days at mid-latitudes
	2 satellites (nadir view)	0.5 day (mean)	–
Spatial sampling interval at SSP (km)		0.5 km VIS-SWIR 1 km IR-Fire	1 km
Spectral channel centre, $\lambda$ ( $\mu\text{m}$ )	VIS	0.555; 0.659; 0.865	0.555; 0.659; 0.865 <sup>a</sup>
	SWIR	1.375; 1.610; 2.25	1.610
	MWIR/TIR	3.74; 10.85; 12	3.74; 10.85; 12
	Fire1/2	3.74; 10.85	
Radiometric resolution	VIS (A = 0.5%)	SNR >20	SNR >20
	SWIR (A = 0.5%)	SNR >20	SNR >20
	MWIR (T = 270K)	NE $\Delta$ T < 80mK	NE $\Delta$ T < 80mK
	TIR (T = 270K)	NE $\Delta$ T < 50mK	NE $\Delta$ T < 50mK
	Fire-1 (<500K)	NE $\Delta$ T < 1K	
Fire-2 (<400K)	NE $\Delta$ T < 0.5K		
Radiometric accuracy	VIS–SWIR (A = 2–100%)	<2% (BOL) <5% (EOL)	<5%
	MWIR–TIR (265–310K)	<0.2K (0.1K goal)	<0.2K
	Fire (<500K)	<3K	
Design lifetime <sup>b</sup>		7.5 years	ATSR-1 & 2: 3 years AATSR: 5 years

A, albedo; BOL, beginning of life; EOL, end of life; SSP, subsatellite point; NE $\Delta$ T, Noise-Equivalent Temperature Difference.

<sup>a</sup> These channels were present for the AATSR and ATSR-2, but not the ATSR-1.

<sup>b</sup> Some instruments remain in operation for much longer than their 'design lifetimes'. Launched in 2002, Envisat's AATSR, for example, was designed for 5 years, but continued to operate for almost 10 years until 2012. Similarly, ERS-1 has provided an uninterrupted series of ATSR-type data and data products since its launch in 1991.

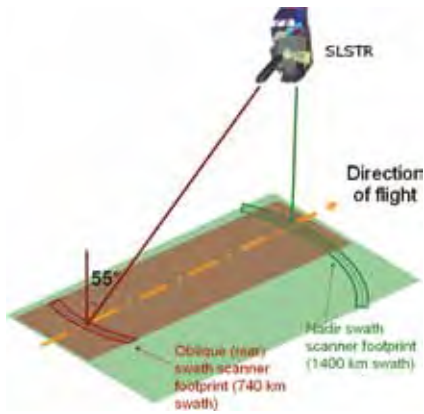

Figure 6.1. The SLSTR instrument viewing geometry, highlighting the asymmetric nadir swath with respect to the nadir point. (TAS-F)

driven important changes in the design of the SLSTR instrument compared with its predecessors. The dual-view concept, one of the prerequisites for highly accurate surface temperature data, has been maintained, but the demand for better coverage requires an increased swath (in both dual and near-nadir views). A two-point onboard blackbody calibration subsystem and an onboard diffuser are used to calibrate the IR and visible channels, respectively, following the heritage of the (A)ATSR instruments. The SLSTR uses highly customised multiple-diode arrays to provide increased spatial resolution in the visible and SWIR bands compared with the (A)ATSR series, and greatly facilitating cloud flagging in TIR image data (clouds are the largest single source of error for satellite SST retrieval). Full overlap with the S-3 OLCI instrument swath has been implemented to facilitate the application of the OLCI and SLSTR in synergy.

Both the OLCI and SLSTR instruments require a clear view of the Sun for the purpose of calibration, and accommodating both instruments on the same platform resulted in the SLSTR oblique view pointing backwards. This configuration is different from that of the Envisat (A)ATSR. Figure 6.1 shows a sketch of the SLSTR instrument viewing geometry, highlighting the asymmetric nadir swath with respect to the nadir point.

### 6.1.1 Instrument Concept

Following Envisat/AATSR, the SLSTR instrument is a conical scanning imaging radiometer employing the along-track scanning dual-view technique (Edwards et al., 1990) to provide robust atmospheric correction over a dual-view swath. To maintain continuity, the complete suite of Envisat/AATSR spectral channels have been included in the SLSTR design. Additional channels at 1.378  $\mu\text{m}$  and 2.25  $\mu\text{m}$  have been introduced to enhance thin cirrus cloud detection (Gao et al., 1993). The design also includes the capability to measure active wildfires (Wooster et al., 2005); this has been achieved by extending the dynamic range of the 10.8  $\mu\text{m}$  channel and including dedicated detectors at 3.7  $\mu\text{m}$  that are capable of detecting fires at ~650K without saturation.

Figure 6.2 shows the key SLSTR instrument features and components. The SLSTR is separated into two physical units that are integrated onto a single plate: the SLSTR Optical Scanning Unit (SLOSU; see Fig. 6.3) that houses the Optomechanical Enclosure (OME) and Detection Assembly (DA), and a separate SLSTR Control and Processor Electronics unit.

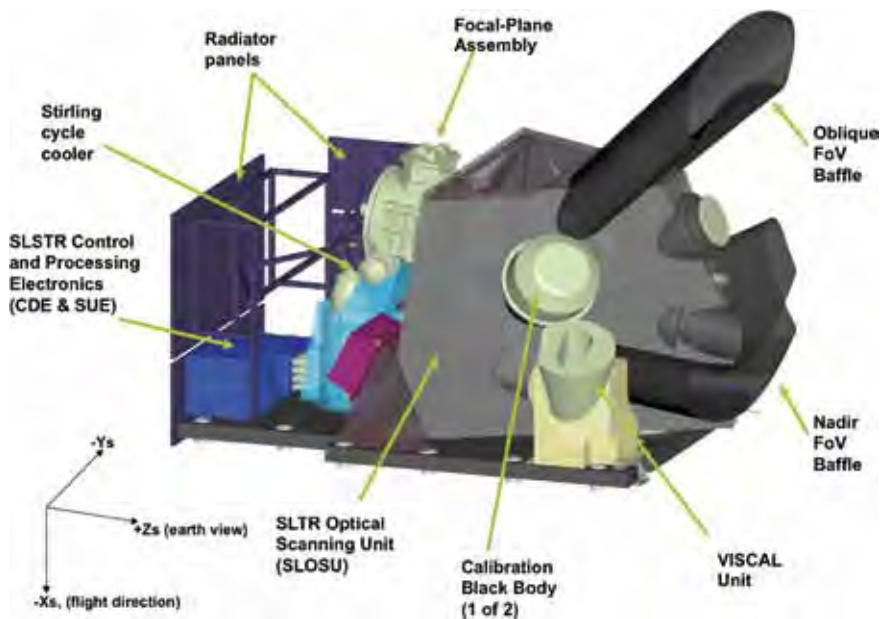

Figure 6.2. Principal components of the SLSTR instrument. (TAS-F)





Figure 6.3. The SLSTR Optical Scanning Unit. (IABG)

The SLSTR uses two independent scan chains, each of which includes a separate scan mirror (scanning at a constant velocity of 200 rpm), an off-axis paraboloid mirror, and a folding mirror to focus the measured radiance onto the detectors. An innovative recombination ‘flip’ mirror alternately relays each of the scanned optical beams into a common field plane at the entrance to the Detection Assembly, where there is a cold baffle. This configuration increases the instrument’s oblique view swath to ~750 km (centred at the SLSTR nadir point) and the nadir swath to ~1400 km (offset in a westerly direction).

Figure 6.4 shows a functional block diagram of the SLSTR instrument. The Focal Plane Assembly (FPA) is a box composed of a base plate and an aluminium dome containing the IR and visible (VIS) optical benches (see Fig. 6.5). Two-element photoconductive detectors are used for the TIR channels, which are actively cooled to ~80K using a Stirling cycle cooler. Small multi-element arrays of photovoltaic detectors are used for the other channels. Active cooling is only provided to the IR and SWIR channels, while the visible channels remain at ambient temperature (see Fig. 6.6). The ground sampling distance at nadir is ~1 km for the TIR/MWIR channels, and ~0.5 km for the visible and SWIR channels. The scan rate is defined so that each mirror scan will simultaneously measure two along-track pixels of 1 km (and 8 pixels at 0.5 km resolution). Each visible (VIS) channel pixel sample achieves a high signal-to-noise ratio ( $SNR \approx \Delta 600$ ) at 30% Earth albedo signals, and each IR pixel sample a low noise-equivalent temperature difference (NEAT) < 80mK.

The Structural and Thermal Model (STM) of the SLSTR instrument is shown in Fig. 6.8. Due to its double telescope, the SLSTR is far larger than its predecessors. The maximum envelope of the optical head is: height  $X = 1315$  mm ( $-X =$  satellite direction), width  $Y = 1075$  mm ( $-Y =$  cold space) and depth  $Z = 1497$  ( $+Z =$  nadir view), with a volume of  $2.116 \text{ m}^3$ . The overall instrument mass is estimated to be 140 kg. Also, because of the larger number of detectors, and their complexity, the power consumption is also higher, estimated to be of the order of 155 W. Finally, the average SLSTR science data rate will amount to 6.43 Mbit/s per orbit.

Figure 6.4. Functional block diagram of the SLSTR Detection Assembly. (TAS-F)

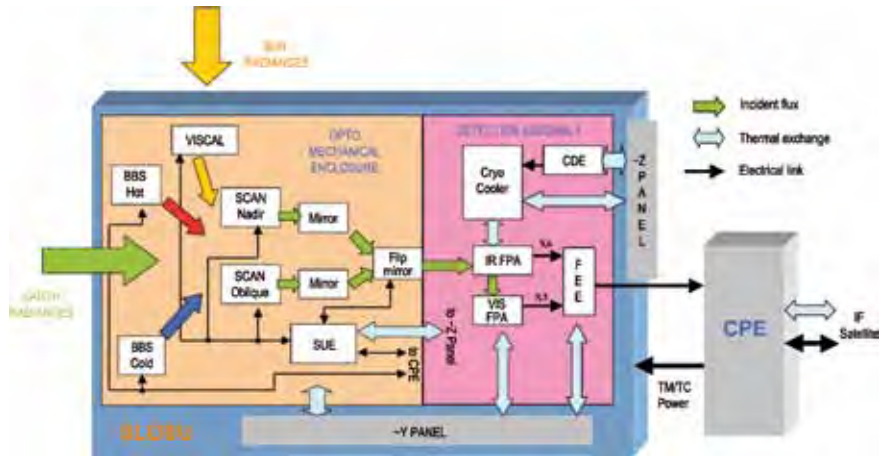
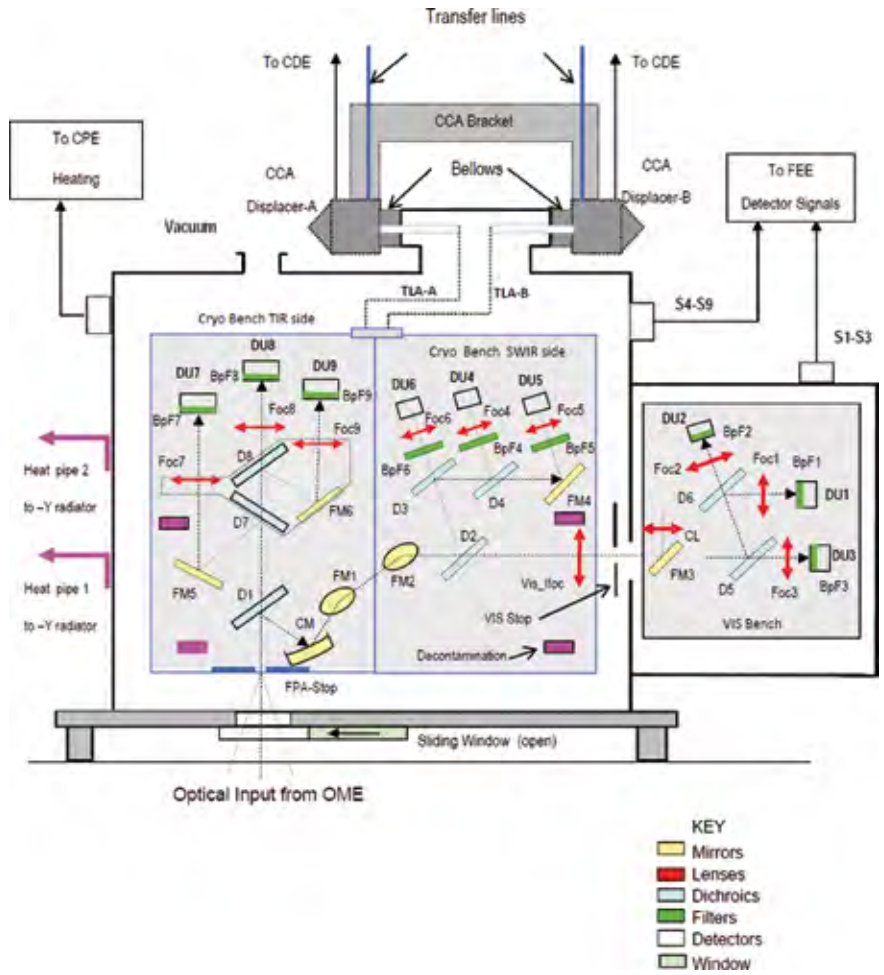

Figure 6.5. Optical schematic of SLSTR IR and VIS FPA (TAS-F)



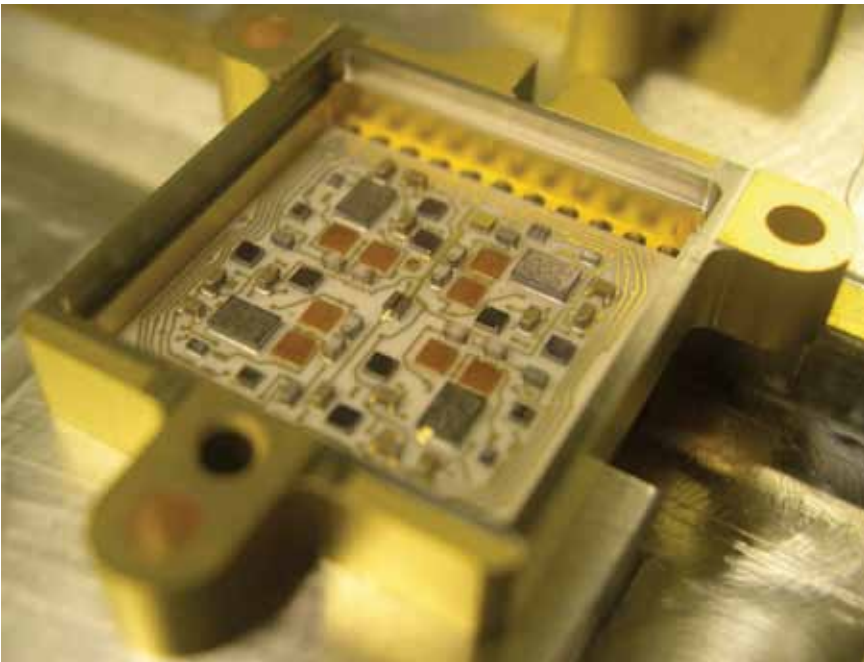

Figure 6.6. The SLSTR visible channel detector. (OSI)

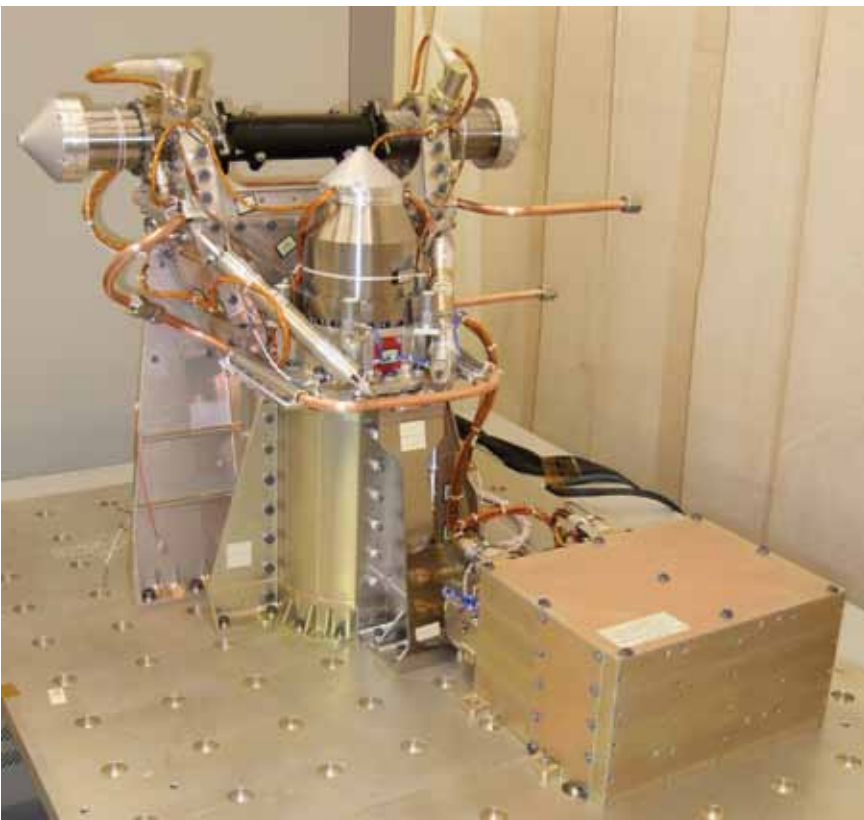

Figure 6.7. Engineering Model of the SLSTR cryocooler system (cryocooler assembly and cooler drive electronics). (Astrium UK)

Figure 6.8. Structural and Thermal Model of the SLSTR, showing the large kidney-shaped Earth-view baffles of nadir (bottom) and oblique (top) views. (IABG)



### 6.1.2 Calibration and Characterisation

Besides a comprehensive on-ground calibration and characterisation programme, the SLSTR will be continuously calibrated throughout the mission using onboard and vicarious calibration techniques. Taking advantage of the instrument's conical scan concept, each scanner will view alternately at every scan, one of two identical calibration blackbody cavities kept at two different temperatures. The SLSTR also includes a PTFE Sun diffuser (see below) for visible channel gain calibration that is viewed once per orbit.

The SLSTR design ensures the spectral and radiometric integrity of all measurements because both the oblique and nadir measurements are made through common focal plane optics. Up to  $2.25\ \mu\text{m}$ , i.e. for channels 1–6, the instrument is calibrated by observing a PTFE diffuser protected by a UV filter and illuminated by the Sun. This diffuser forms the core part of the visible calibration unit (see Fig. 6.9). Since the Sun is not visible all the time, this calibration will take place only once per orbit, just before the terminator crossing of the satellite in the southern hemisphere.

Calibration of the infrared channels S7 to S9 and two fire channels will be ensured continuously (i.e. every second scan) by observing the two stable and highly accurate blackbody targets. One target floats at the temperature of the instrument optics enclosure, and the other is maintained at a higher temperature by active heaters. This combination provides two calibration points spanning the normal range of SSTs. Note that additional vicarious techniques will be used to calibrate the upper range of SLSTR Fire channels, as this is beyond the operating temperature of the onboard blackbodies. The blackbodies for the SLSTR are based on a design already used for the (A)ATSR sensors. The viewed areas of the blackbodies have a very high emissivity ( $e > 0.999$ ) and are spatially very uniform. The temperatures of the blackbodies will be measured with high-accuracy platinum resistance thermometers calibrated on the ground against a transfer standard traceable to ITS-90, the international temperature scale of 1990.

To ensure the stability and high quality of SLSTR data products, rigorous and accurate pre-flight characterisation and calibration of the SLSTR blackbody sources are essential. Validation activities will include comparing derived L2 products with *in situ* reference SST measurements, comparisons with other

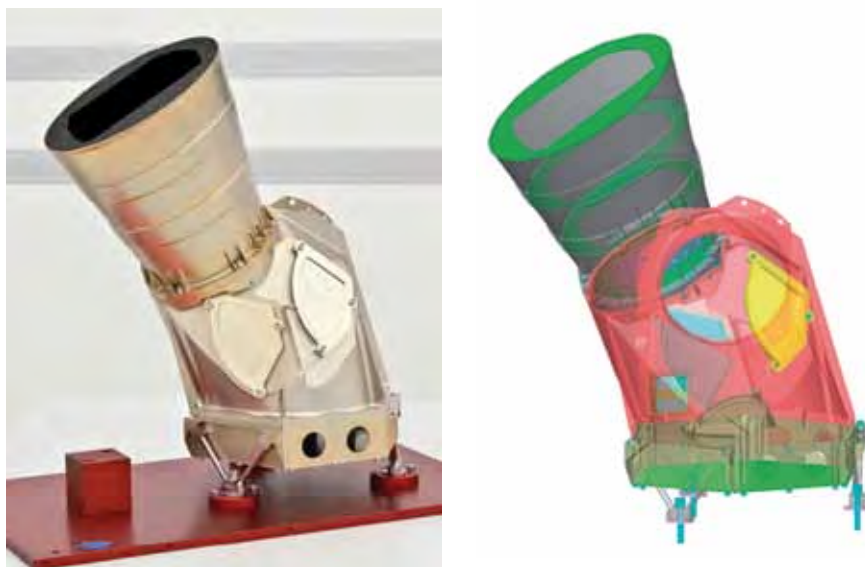

Figure 6.9. The SLSTR visible calibration unit. (Selex Galileo/TNO)

satellite top-of-atmosphere data, direct comparisons of measurements made over selected desert and ice targets, calibration using Rayleigh scattering over oceans and long-term trend analysis.

## 6.2 The Ocean and Land Colour Instrument

After eight years of successful ocean and land colour observations from the Envisat/MERIS instrument, launched in 2002, the design and development of its successor started. The OLCI design is inherited from that of MERIS with many improvements. These include an increase in the number of spectral bands (from 15 to 21), a reduction in the Sun-glint effect by tilting the camera in westerly direction, permanent acquisition in full spatial resolution (FR, 300 m) over the entire orbit (i.e. over land and ocean), improved characterisation (e.g. straylight, camera overlap), improved coverage (oceans <4 days, land <3 days; MERIS effectively 15 days), and a complete swath overlap with the SLSTR.

### 6.2.1 Instrument Concept

Following the design of MERIS, the OLCI is a push-broom imaging spectrometer consisting of five cameras in a fan-shaped arrangement, sharing the complete field-of-view (Fig. 6.10). The OLCI swath is not centred at nadir (as in the MERIS design) but is tilted  $12.6^\circ$  westwards to mitigate the negative impact of Sun-glint contamination that affected almost half of MERIS observations at subtropical latitudes (e.g. Kay et al., 2009). Each camera has an individual FOV of  $14.2^\circ$  with a  $0.6^\circ$  overlap with its neighbours. As a result, the OLCI will cover the ocean surface in less than 4 days with one satellite.

The OLCI will observe Earth's surface with a swath width of the order of 1270 km over Europe and varying slightly with latitude, and an instantaneous FOV of 300 m max at the Sub-Satellite Point (SSP) over land and ocean.

The instrument will be mounted on the top of the Sentinel-3 satellite to allow a direct view of Earth, removing the need for an additional folding mirror as used by MERIS. The main elements of the OLCI imager are shown in Fig. 6.11.

Figure 6.10. Basic geometry of the OLCI, showing the fan arrangement of the five cameras that will view Earth through the calibration assembly and the off-nadir pointing of the instrument swath. The Observation Zenith Angle (OZA) is limited to a maximum of 55°. The swath is 1270 km. The Local Solar Time (LST) of observations is indicated in the lower part of the figure. (GMES)

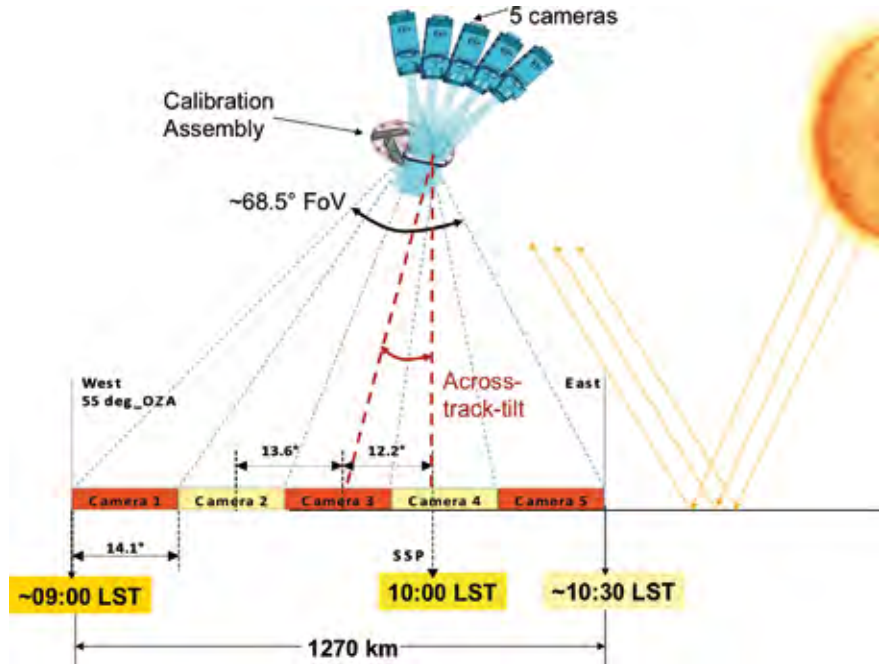
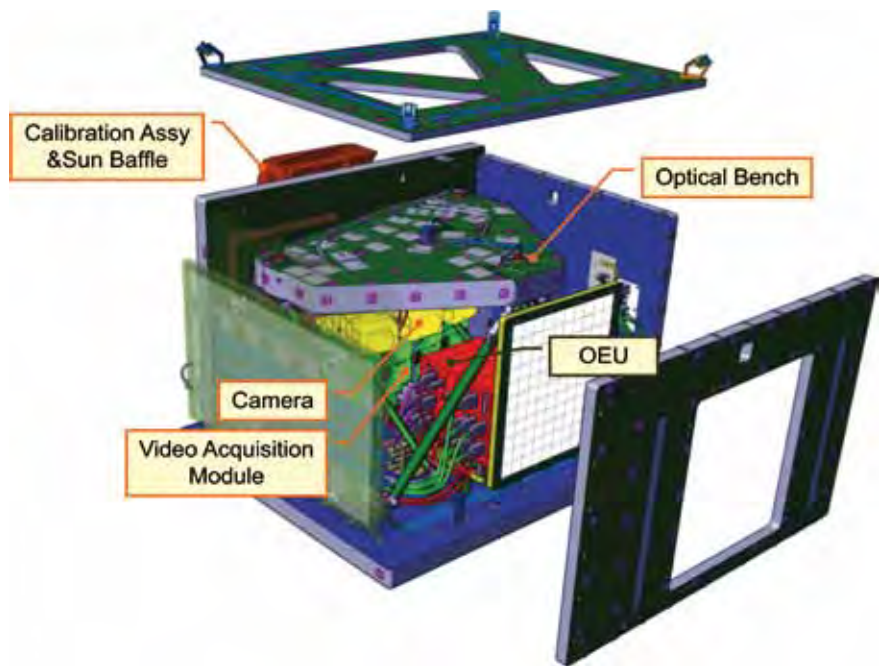

Figure 6.11. Main design elements of the Ocean and Land Colour Instrument. (TAS-F)



Building on the MERIS design, the OLCI includes an optical bench supporting:

- the five fan-arranged Camera Optical Subassemblies (COSAs);
- five Focal Plane Assemblies (FPAs; see Fig. 6.12);
- a Scrambling Window Assembly (SWA);
- five Video Acquisition Modules (VAMs) containing the whole analogue imaging chains down to digital conversion;
- the OLCI Electronics Unit (OEU) that manages all the instrument functions;
- the calibration assembly, which performs radiometric and spectral calibration; and
- heat pipe networks that ensure the thermal control of the VAMs, FPA and detectors.

Figure 6.13 shows the same subsystems as a functional block diagram indicating how they will interact when generating the data outputs (digitised images and housekeeping data) from external stimuli. An Engineering Model of one of the five cameras is shown in Fig. 6.14.

The OLCI will measure 21 spectral bands with an SNR that will allow the generation of ocean, land and atmospheric data products similar to those generated by the 15 MERIS spectral bands. Six additional spectral bands in the range 390–1040 nm will provide the data for improved water constituent retrieval (at 400 nm and 673.75 nm), improved atmospheric correction (at 1020 nm) over coastal waters and improved retrieval of atmospheric parameters (e.g. atmospheric pressure over land surfaces and cloud pressure, making use of the O2A-band (at 760–775 nm). Details of the OLCI band settings are shown in Table 6.2.

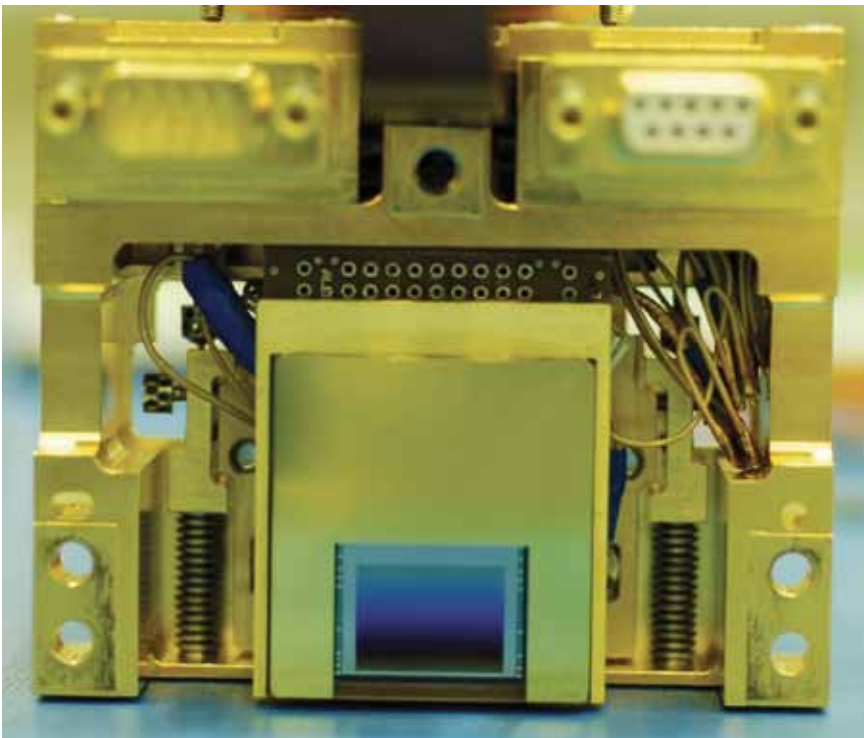

Figure 6.12. Engineering Model of the Focal Plane Assembly of the Ocean and Land Colour Instrument. (TAS-F)

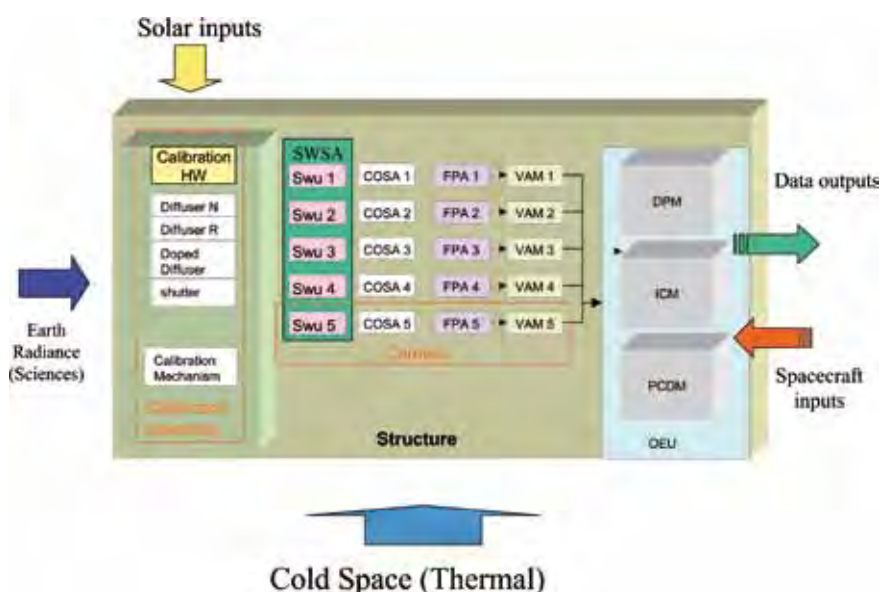

Figure 6.13. Functional block diagram of the Ocean and Land Colour Instrument.

Figure 6.14. Engineering Model of one of five cameras of the Ocean and Land Colour Instrument. (TAS-F)



The OLCI bands have been optimised to measure ocean colour over the open ocean and coastal zones. A channel at 1.02  $\mu\text{m}$  has been included to improve atmospheric and aerosol correction capabilities, channels in the O2A spectral region have been included for improved cloud top pressure (height) and water vapour retrieval, and a channel at 673 nm is provided for improved measurements of chlorophyll fluorescence. In principle, the OLCI programmable acquisition design will allow the location and width of the spectral bands to be redefined – if necessary – during the commissioning of the instrument, after which time they will be fixed for the duration of the mission.

Table 6.2. Band characteristics of the OLCI, with shading on the additional bands that were not used by MERIS. SNR calculations are shown for reduced resolution.

Band	$\lambda$ centre (nm)	Width (nm)	$L_{\min}$ ( $\text{W m}^{-2} \text{sr}^{-1} \mu\text{m}^{-1}$ )	$L_{\text{ref}}$ ( $\text{W m}^{-2} \text{sr}^{-1} \mu\text{m}^{-1}$ )	$L_{\text{sat}}$ ( $\text{W m}^{-2} \text{sr}^{-1} \mu\text{m}^{-1}$ )	SNR @ $L_{\text{ref}}$
Oa1	400	15	21.60	62.95	413.5	2188
Oa2	412.50	10	25.93	74.14	501.3	2061
Oa3	442.50	10	23.96	65.61	466.1	1811
Oa4	490	10	19.78	51.21	483.3	1541
Oa5	510	10	17.45	44.39	449.6	1488
Oa6	560	10	12.73	31.49	524.5	1280
Oa7	620	10	8.86	21.14	397.9	997
Oa8	665	10	7.12	16.38	364.9	883
Oa9	673.75	7.5	6.87	15.70	443.1	707
Oa10	681.25	7.5	6.65	15.11	350.3	745
Oa11	708.75	10	5.66	12.73	332.4	785
Oa12	753.75	75	4.70	10.33	377.7	605
Oa13	761.25	2.5	2.53	6.09	369.5	232
Oa14	764.375	3.75	3.00	7.13	373.4	305
Oa15	767.50	2.5	3.27	7.58	250.0	330
Oa16	778.75	15	4.22	9.18	277.5	812
Oa17	865	20	2.88	6.17	229.5	666
Oa18	885	10	2.80	6.00	281.0	395
Oa19	900	10	2.05	4.73	237.6	308
Oa20	940	20	0.94	2.39	171.7	203
Oa21	1020	40	1.81	3.86	163.7	152



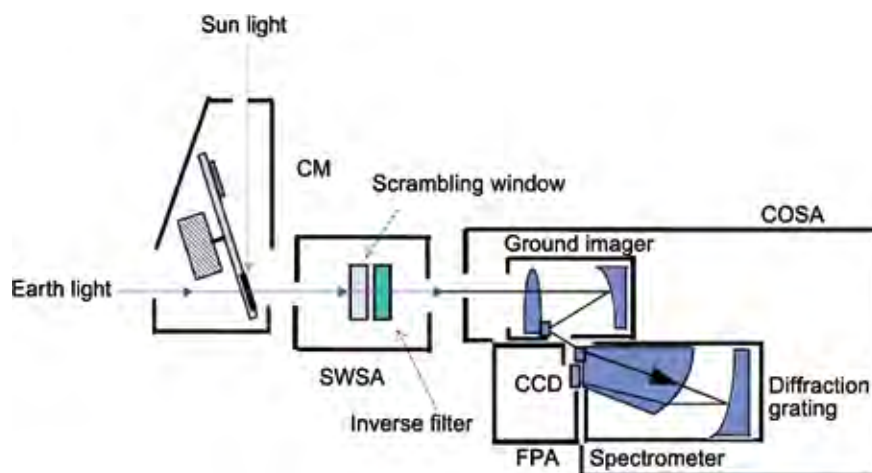

Figure 6.15. Layout of an OLCI camera. CM, Calibration Mechanism; SWSA, Scrambling Window Assembly; COSA, Camera Optics Subassembly; CCD, Charged-Coupled Device; FPA, Focal Plane Assembly. (TAS-F)

The optical layout of an OLCI camera is shown in Fig. 6.15. The ground imager of the Camera Optics Subassembly collects light through the calibration assembly (either from Earth or the Sun-illuminated diffusers) and the Scrambling Window, which is then focused in the spectrometer entrance slit. The spectrometer generates a dispersed image of the slit on a two-dimensional CCD array, where one dimension is the spatial extension of the slit, and the other the spectral dispersion of the slit image in the range 390–1040 nm.

The envelope of the instrument is 1244 × 828 × 1315 mm, with an estimated mass of 153 kg and a power consumption of 124 W.

## 6.2.2 Calibration and Characterisation

A comprehensive on-ground calibration and characterisation programme will allow confirmation of the performance of the OLCI instrument before launch. It will be calibrated after launch using both onboard and vicarious calibration techniques. Inflight calibration of the OLCI is a fundamental component of the instrument design. Onboard calibration makes use of the sunlight reflected (diffused) from a near-lambertian diffuser made of PTFE. Three diffusers are actually used, covering spectral calibration, gain calibration and ageing effects.

All OLCI measurements will be made via a calibration assembly with a design similar to that of MERIS. Either a direct view of Earth (for imaging mode) or one of several calibration targets integrated into the calibration mechanism (Fig. 6.16) may be selected: a dark shutter plate (for dark current calibration), a primary PTFE calibration diffuser (viewed every two weeks for radiometric calibration), a redundant PTFE calibration diffuser (viewed every three months to assess degradation of the primary diffuser due to solar exposure) or an erbium-doped ‘pink’ diffuser plate for spectral calibration. During the calibration sequence, the selected diffuser plate will be moved into the instrument FoV and illuminated by the Sun so that all five cameras can be calibrated at the same time. Characterisation of diffuser ageing will be determined through on-ground processing using the two OLCI diffusers in synergy.

The OLCI calibration sequence will be carried out before the terminator crosses over to the southern hemisphere to maintain a stable internal instrument temperature in a manner similar to that used for MERIS. Two successive orbits will be required: the first for radiometric calibration and the second for spectral calibration. Each calibration sequence begins with a dark current evaluation. This sequence will last 45 s and acquires 1024 measurement frames that will be averaged on the ground to reduce noise, and used for the accurate derivation of the signal produced under dark conditions.

Figure 6.16. The OLCI calibration mechanism. (TAS-F)

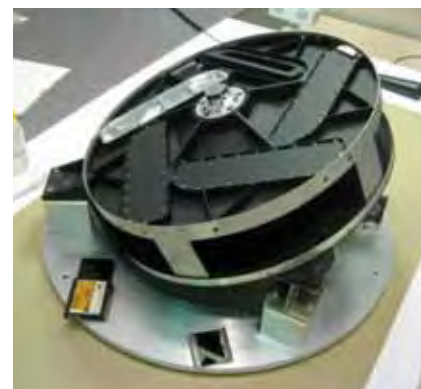

The vicarious calibration methods used after launch will include simultaneous *in situ* measurements of natural targets (absolute calibration), monitoring of stable desert sites (relative multisensor, multitemporal, multi-angular calibration), absolute calibration using Rayleigh scattering over clear water and relative interband calibration making use of observations of Sun glint.

## 6.3 The Synthetic Aperture Radar Altimeter

The SRAL altimeter is the core instrument of the topography mission carried on Sentinel-3, and has been designed to collect consistent, long-term altimeter range measurements over different types of surface. SRAL range measurements between the satellite and the surface will be converted to surface height measurements along the satellite track, after appropriate processing on the ground, and using the accurate knowledge of the satellite height above Earth's ellipsoid provided by the POD instrumentation.

The basic principle of operation of the SRAL relies on the measurement of the time it takes for an RF pulse to travel from the antenna to the surface and back again after reflection at the sea surface. The measured time delay is then converted to distance (or range) by dividing it by the speed of the travelling pulse (speed of light). However, the speed of the pulse is affected (slowed down) by ionospheric activity, atmospheric gases and water (in either liquid or vapour form) in the troposphere. Therefore, in order to convert the delay into a valid range measurement, ionospheric and wet-tropospheric range delay errors must be removed. Different techniques will be used for these compensations: using the delay measured in two different frequency bands by the radar it will be possible to derive the bias introduced by the ionosphere, while the measurement of the water content of the atmosphere will be derived from Microwave Radiometer measurements over the same area. The effect of tropospheric gases is predictable and appropriate atmospheric model outputs can be used to derive the corresponding corrections.

Conventional radar altimeters that have been operating during the last two decades have used the 'pulse-limited' ranging technique combined with 'deramp' pulse compression. The benefits of these methods are mainly technological (i.e. high range accuracy is achieved with limited processed signal bandwidth and with low RF peak power), but imply permanent echo tracking. In addition, the range derived by this method is actually related to the average surface height of a large area illuminated by the antenna footprint, of the order of 15–20 km in diameter. Consequently, the accuracy of this measurement cannot be ensured unless the surface topography in this large area is homogeneous, as it is in the case of the ocean surface. In order to extend the measurement capabilities of the Sentinel-3 altimeter over other areas of particular interest with higher topographic variability (e.g. ice margins, land/sea transitions, rivers and lakes), an SAR mode has been included in the SRAL instrument that was used for the first time on CryoSat-2.

SAR processing enhances the along-track resolution of each individual measurement. This brings an additional benefit, in that it is possible to observe rapid changes in surface topography along the satellite track, whereas conventional altimeters average and smooth out such variations. This capability is particularly suited to observations of coastal areas, where the sea surface height is changing on smaller spatial scales than in the open ocean.

### 6.3.1 SRAL Architecture and Modes

The SRAL instrument (see Fig. 6.17) comprises one nadir-looking antenna, which is externally mounted on the satellite's  $+Z_s$  Earth panel, and a central electronic chain composed of a Digital Processing Unit (DPU) and a Radio

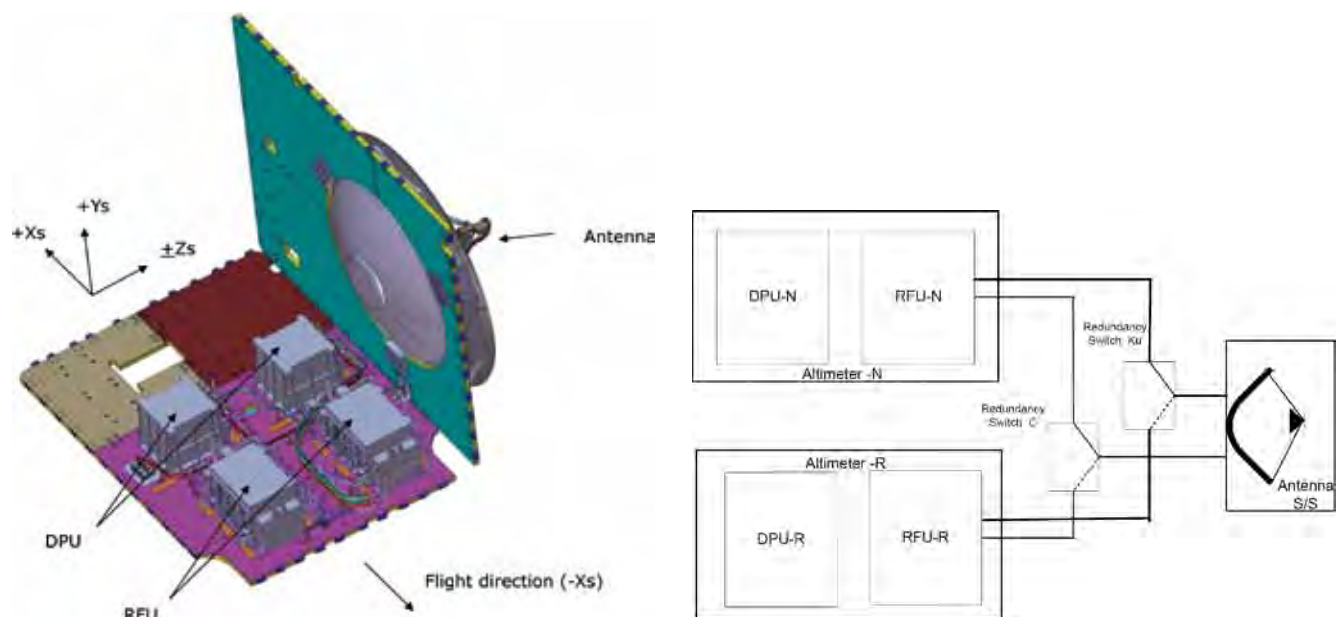

Figure 6.17. The SRAL instrument, showing its accommodation on the satellite panels (*left*) and its functional architecture (*right*). (TAS-F)

Frequency Unit (RFU). The central electronic chain is mounted inside the satellite on the  $-Y_s$  panel in a cold redundant configuration. The main frequency used for range measurements is the Ku-band (13.575 GHz, bandwidth 350 MHz), while the C-band frequency (5.41 GHz, bandwidth 320 MHz) is used for ionosphere correction.

The SRAL instrument includes measurement, calibration and support modes. The measurement modes (see Fig. 6.19) are composed of two radar modes combined with two tracking modes. The two radar modes are:

- Low-Resolution Mode (LRM): conventional altimeter pulse-limited mode based on a 3 Ku/1C/3Ku pulse pattern; and
- SAR mode: high along-track resolution mode composed of bursts of 64 Ku-band pulses surrounded by two C-band pulses.

The two tracking modes provided in the SRAL design are:

- closed-loop mode: autonomous positioning of the range window using the median algorithm; and
- open-loop mode: range window position based on a priori knowledge of terrain altitude derived from a Digital Elevation Model (DEM), which is loaded in a 4 Mbit EEPROM within the DPU.

There are also two calibration modes that allow the measurement of the internal instrument impulse response (by looping back a fraction of the transmit signal) and the determination of the transfer function of the receive chain, derived from the acquisition and averaging of thousands of noise samples.

The SAR mode provides an enhanced along-track (azimuth) resolution of the order of 300 m. This feature allows the acquisition of height measurements over along-track sliced areas sampled at the azimuth resolution. The final resolution cells are the result of the intersection between resolution cells of the LRM mode (rings) and the iso-Doppler lines provided by the SAR mode (see Fig. 6.18).

The transitions between measurement modes (Fig. 6.19) have been designed to allow switching from one measurement mode to the other without a transition to standby mode in order to save time during transitions and maintain data collection.

Note that the LRM mode in open loop can only be accessed from standby mode since this mode is not considered an operational mode.

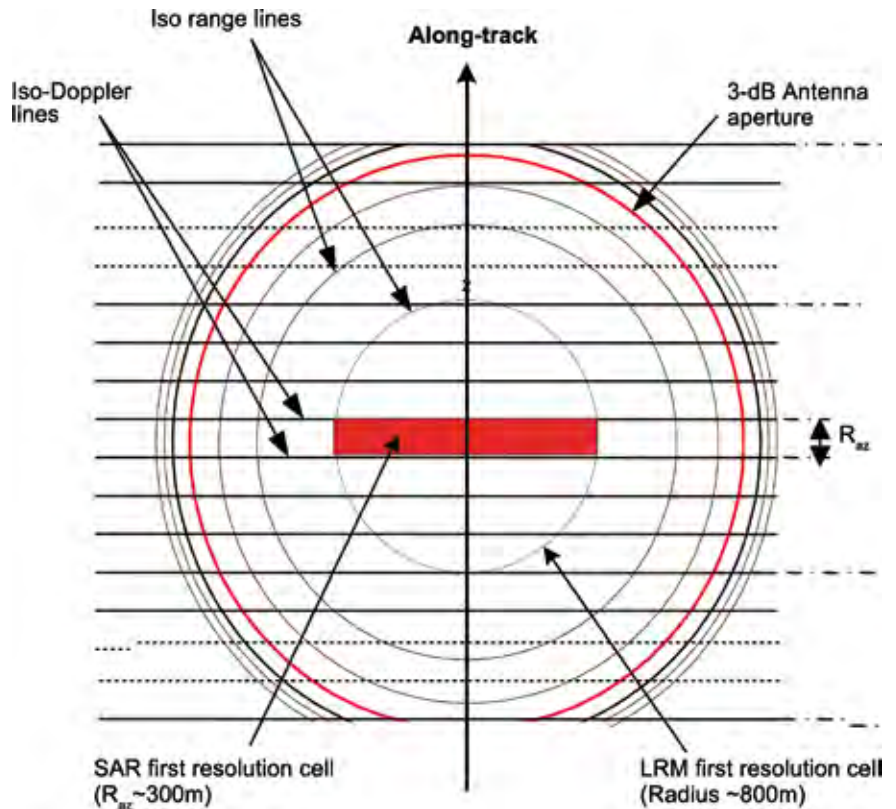

Figure 6.18. Final shape of resolution cells in SAR mode. The resolution of along-track range cells,  $R_{az} \approx 300$  m for the SRAL. (TAS-F)

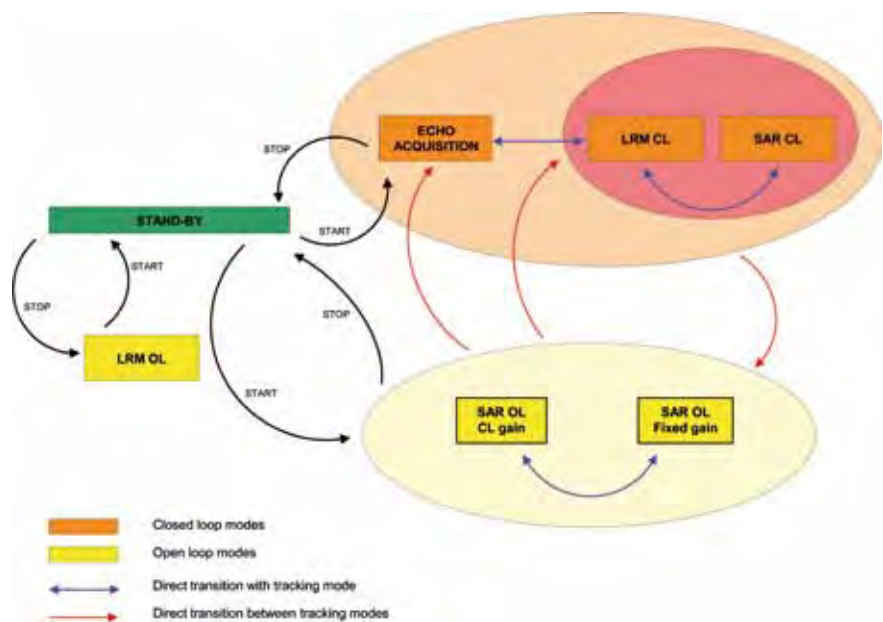

Figure 6.19. Overview of SRAL measurement modes and transition options between modes. (TAS-F)

### 6.3.2 SRAL Budgets and Performance

The SAR mode is more challenging than the LRM mode since the duty cycle of the Ku-band high-power amplifier is higher in that mode (~28%) than in the LRM mode (~8%). In addition, due to the large number of pulses and the transmission of raw (non-accumulated) echoes, the output data rate of the SAR mode is much higher than that of the LRM mode (Table 6.3).

The Signal-to-Noise Ratios (SNRs) computed for different surfaces are presented in Table 6.4. Note that the azimuth processing of the SAR mode provides an additional 12.3 dB gain for the SNR. This leads to adequate values of SNRs after SAR processing also on low-reflectivity surfaces such as ice ( $\sigma^0 = 0$  dB) and even ice margins ( $\sigma^0 = -10$  dB).

The altimetry accuracy (or range noise) over open ocean of the SRAL in the LRM mode (Ku-band) is shown in Fig. 6.20 as a function of Significant Wave Height (SWH) and for a 1-s averaging.

A typical figure for SWH = 2 m is 1.3 cm RMS. In SAR mode, this figure is expected to be less than 1 cm because of the larger number of looks integrated over 1 s.

Instrument	
Mass	<62 kg
Reliability @ 30°C	>0.92
Power consumption	LRM mode: 90 W      SAR mode: 100 W
Data rates	LRM mode: 100 kbit/s      SAR mode: 12 Mbit/s

Table 6.3. SRAL budgets.

Band	RF power (W)	$\sigma^0$ min (dB)	LRM SNR (dB)	SAR SNR (dB)
Ku	7	8 (ocean)	14.4	26.7
		0 (ice)	6.4	18.7
		-10 (ice margins)	-3.6	8.7
C	31	12 (ocean)	11.1	NA

Table 6.4. SRAL SNR budgets.

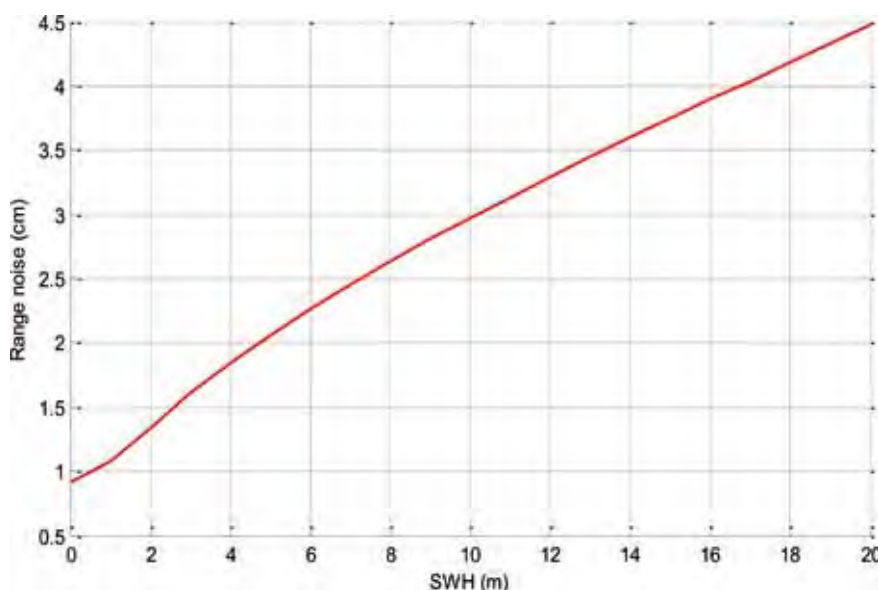
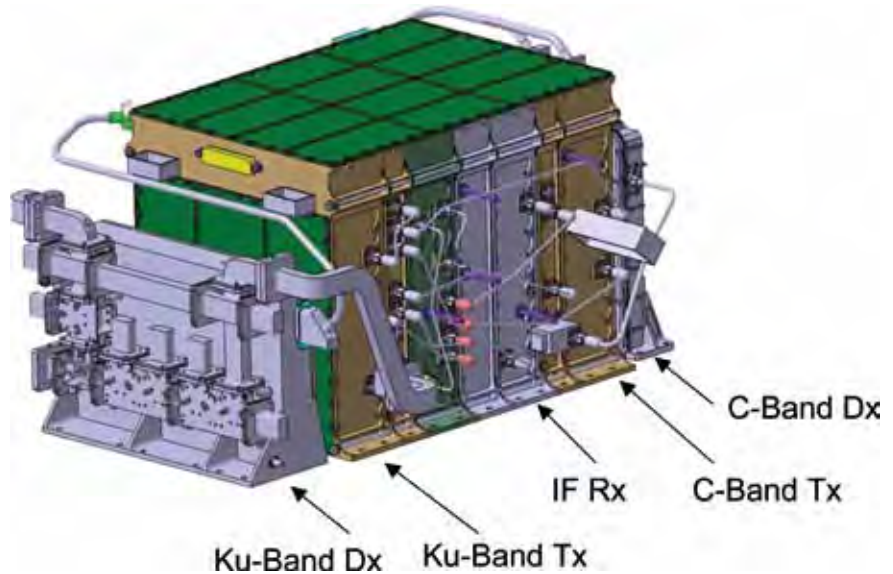

Figure 6.20. SRAL range noise in the LRM mode (Ku-band). (TAS-F)

Figure 6.21. The SRAL Radio-Frequency Unit. (TAS-F)



### 6.3.3 Overview of SRAL Components



Figure 6.22. Engineering model of the SRAL antenna. (MDA)

The three main SRAL components (antenna, RFU and DPU) are described in the following paragraphs. Note that C- and Ku-band switches are used to provide redundancy between the nominal and redundant central electronic chains.

The DPU consists of a stack of six boards plus an interconnection board. Its main functions are:

- generation of a reduced-bandwidth digital chirp signal, centered at 50 MHz at Pulse Repetition Frequency (PRF) rate;
- processing of deramped echoes including digitisation, I/Q demodulation, Fast Fourier Transform and echo accumulation;
- transmission of science data via the Spacewire link;
- echo processing (range and tracking) for the closed-loop mode operation;
- storage and management of the onboard Digital Elevation Model for open-loop tracking; and
- management of 1553 TM/TC interface with the platform.

The RFU (see Fig. 6.21) is made up of slices stacked together except for the C- and Ku-band duplexers, which will be fixed independently on the satellite panel. The RFU will upconvert chirp signals from 50 MHz to the C- and Ku-bands, and provide an output power of 38 dBm (9 W) in the Ku-band and 43 dBm (20 W) in the C-band. The upconversion stage will also include an expansion of the chirp bandwidth by a factor of 16. Received echoes in the C- and Ku-bands will be deramped down to 650 MHz and, finally, a conversion stage will downconvert the signal to 100 MHz, with a useful bandwidth of 2.86 MHz.

The SRAL antenna (see Fig. 6.22) is a 1.20-m parabolic reflector with a centre-fed C/Ku dual-band coaxial feed horn at a focal length of about 430 mm. The feed is supported by three struts separated by an angle of 120°. The antenna provides a minimum gain of 41.5 dBi in the Ku-band and 31.6 dBi in the C-band at boresight in the signal bandwidths. The side-lobe level is lower than -18 dB in the Ku-band to minimise the range ambiguity ratio (Fig. 6.23).

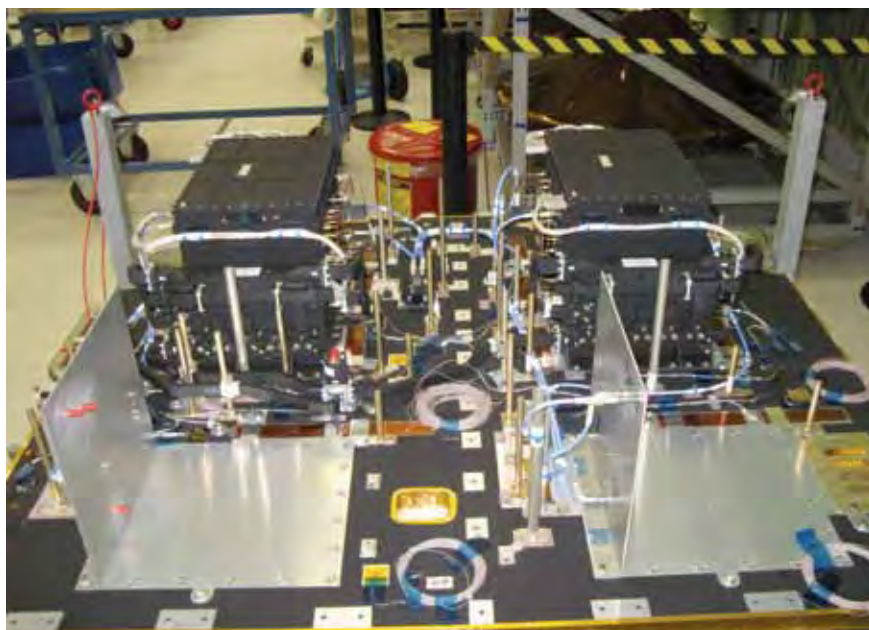

Figure 6.23. The SRAL Radio-Frequency Unit flight hardware showing the A and B side-units integrated into the satellite panel. (TAS-F)

Parameter	Ku-band	C-band
Frequency	13.575 GHz	5.41 GHz
Bandwidth	350 MHz (320 used)	320 MHz (290 used)
Antenna footprint	18.2 km	48.4 km
Radius of 1st resolution cell	823 m	865 m
LRM Pulse Repetition Frequency (PRF)	1924 Hz	274.8 Hz
LRM tracking modes	Closed loop and open loop	
SAR mode		
SAR (PRF)	17 825 Hz	
SAR along-track resolution	291 m (orbit height 795 km) to 306 m (orbit height 833 km)	
SAR across-track resolution	>2 km, depending on Significant Wave Height ( $H_s$ )	
Doppler bandwidth	15 055 Hz	
Tracking modes	Closed loop and open loop	
Antenna size	1.2 m diameter, focal length 0.43 m	

Table 6.5. Technical characteristics of the Sentinel-3 SRAL instrument.

Source	Envisat error (cm)	S-3 error (cm)	Contributor
Altimeter noise	1.8	1.4	SRAL
Sea state bias	2.0	2.0	SRAL
Ionosphere	0.5	0.5	SRAL
Dry troposphere	0.7	0.7	SRAL
Wet troposphere	1.4	1.4	MWR
Total range error	3.1	2.9	
Radial orbit error	1.9	1.9	POD
Sea surface height error	3.6	3.4	

Table 6.6. Estimated Sea Surface Height error budget for the Sentinel-3 topography mission.

### 6.4 The Microwave Radiometer

The primary purpose of the microwave radiometer observations is to correct the delay of the radar altimeter signal while travelling through the atmosphere. The variable part of the delay is caused by the water content of the troposphere and is determined by both the atmospheric integrated water vapour content and by liquid water. The constant part is caused by molecular nitrogen that has a constant and well-known mixing ratio and thus can be accurately predicted using state-of-the-art models. The accuracy of the delay correction is equivalent to a path length of 1.2–1.5 cm.

In addition, MWR measurement data can be useful for the determination of land surface emissivity and soil moisture, for surface energy budget investigations to support atmospheric studies and for ice characterisation. In the frame of the operational Sentinel-3 mission, the delivery of products of this type is a secondary objective.

The design and specifications of the Sentinel-3 MWR (Fig. 6.24) have been based on those of the Envisat MWR. The instrument will measure the brightness temperature at 23.8 GHz and 36.5 GHz covering a bandwidth of 200 MHz in each

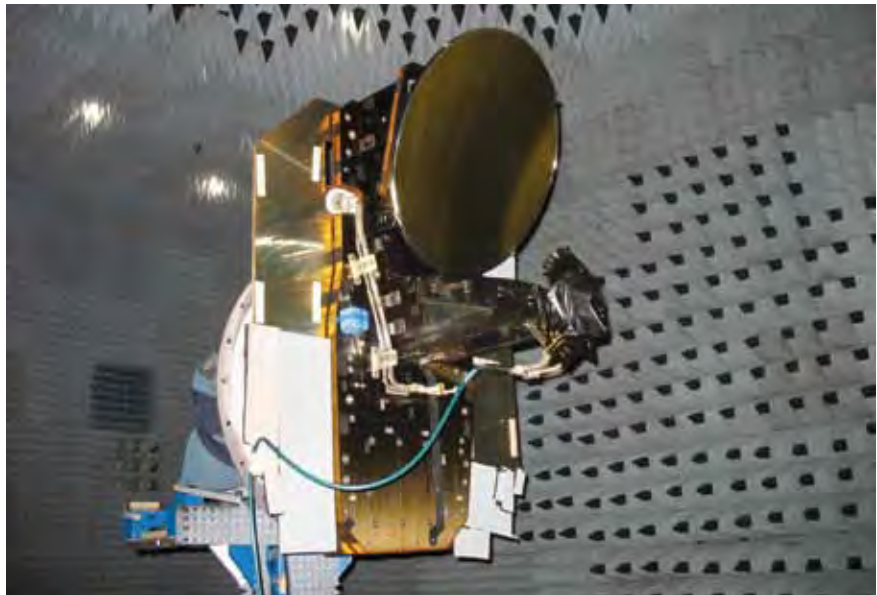

Figure 6.24. The protoflight model of the Microwave Radiometer under test. (EADS-CASA)

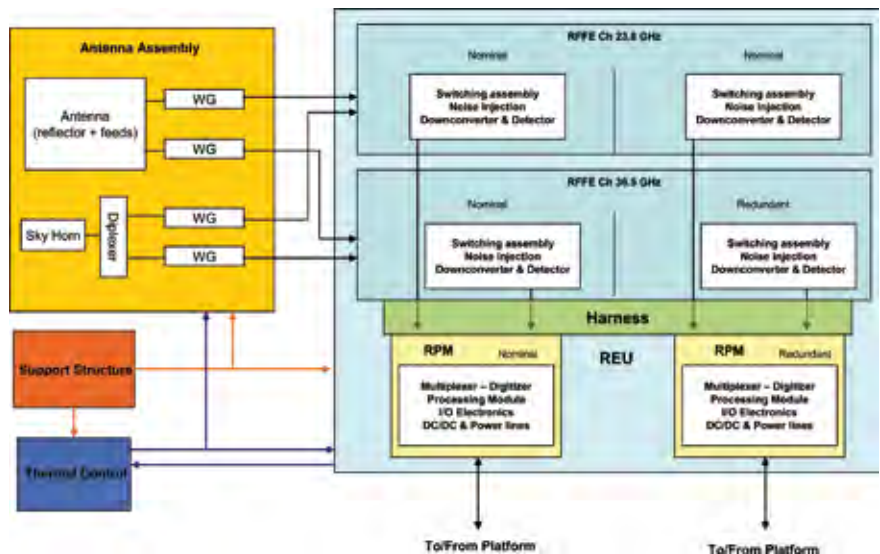

Figure 6.25. Block diagram of the Microwave Radiometer.



channel. The lower-frequency channel is mostly sensitive to atmospheric water vapour and the higher-frequency channel to cloud liquid water. Conceptually, it is a balanced Dicke radiometer for brightness temperatures below the Dicke load temperature. The balancing is achieved by means of a noise injection circuit. For brightness temperatures higher than the Dicke load temperature, a conventional Dicke mode is used. The radiometer employs a single offset reflector 60 cm in diameter and two separate feeds for the two channels. Calibration is achieved through a dedicated horn antenna pointing at the cold sky and the highly stable and precisely monitored internal Dicke load.

The Radiometer Electronics Unit (REU) consists of the Radiometer Processing Module that provides the interface to the satellite's main computer, and the Radio-Frequency Front End that contains the amplifiers, filters and the calibration/redundancy switch assembly (see Fig. 6.25).

### 6.4.1 Radiometer Electronics Unit

The REU consists of the Radio-Frequency Front End (RFFE) and the Radiometer Processing Module (RPM). The RFFE is located as close as possible to the measurement feeds to optimise the length of the waveguides and thus the radiometric performance. Each channel is composed by the Microwave Switch Assembly (six ferrite switches) the Noise Source, the Front End Receiver and the Detector. These elements are shown in Fig. 6.26, where the lid of the 23.8 GHz channel has been removed. The nominal section is shown in the upper half of the figure and the redundant section in the lower half. The 36.5 GHz channel at the back has the same configuration. The RFFE will determine the overall sensitivity of the MWR. A noise figure budget of the RFFE section is presented in Fig. 6.27.

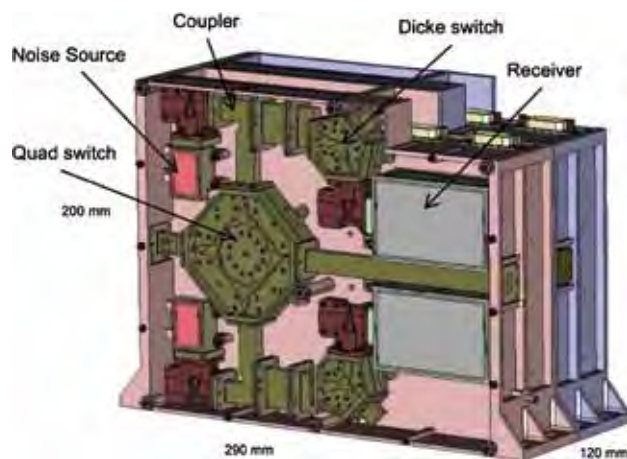

Figure 6.26. The Radio-Frequency Front End, including the nominal and redundant sections. (EADS-CASA)

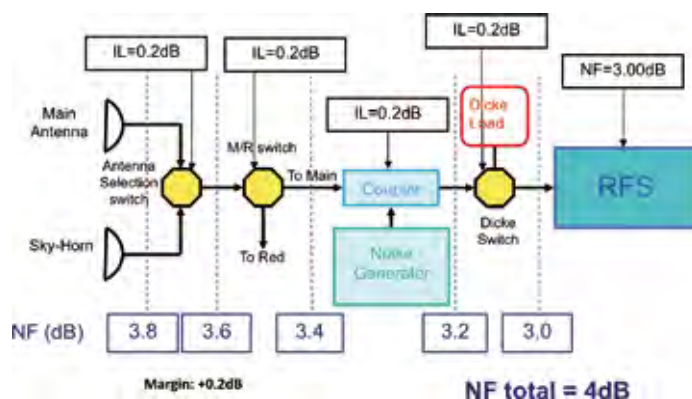

Figure 6.27. Noise figure budget of the Radio-Frequency Front End. (EADS-CASA)

Table 6.7. Main characteristics of the Sentinel-3 MWR.

Characteristic	Details
Frequencies	23.8/36.5 GHz
Bandwidth	200 MHz
Radiometric noise	0.45K <sup>a</sup>
Radiometric stability	0.6K
Radiometric accuracy	<3K
Main antenna diameter	60 cm
3-dB footprint Ø	23.2/16.7 km
Beam efficiency (2.5 HPBW)	93.5/95.8%
Mass	26.5 kg including margins
Power consumption	34 W
Calibration cycle	~1/h
Dicke frequency	78.5 Hz
Integration time	150 ms
<sup>a</sup> Without blanking.	

The Radiometer Processing Module contains the thermal control, the RFFE control, noise injection loop and power supplies (also for the RFFE), and provides the electronic interface to the platform. The REU includes a mode to blank the receiver inputs when the Radar Altimeter emits its pulses in order to avoid potential disturbances. This blank mode is accessible by ground commands.

The main characteristics of the Sentinel-3 MWR are listed in Table 6.7.

### 6.4.2 Antenna Assembly

The antenna assembly consists of the main reflector (diameter 60 cm), the two measurement feeds and the sky horn. The antenna assembly receives the noise temperatures emitted by objects within the antenna’s field of view. Discrimination between the different measurement frequencies is done by using different feed horns, each covering a separate frequency band. A separate cold sky measurement is provided by means of a dedicated sky horn. In this way, during calibration, the satellite will be able to continue the regular nadir measurements without the need for special manoeuvres to point the antenna towards the cold sky for this purpose.

The sky horn receives both channels at the same time. They are separated by a waveguide diplexer. The signals received by the feeds are guided towards the receiver electronics by means of waveguides. The physical temperatures of the different sections of the antenna assembly are measured and acquired by the Radiometer Processing Module of the REU. A sketch of the whole instrument is shown in Fig. 6.28.

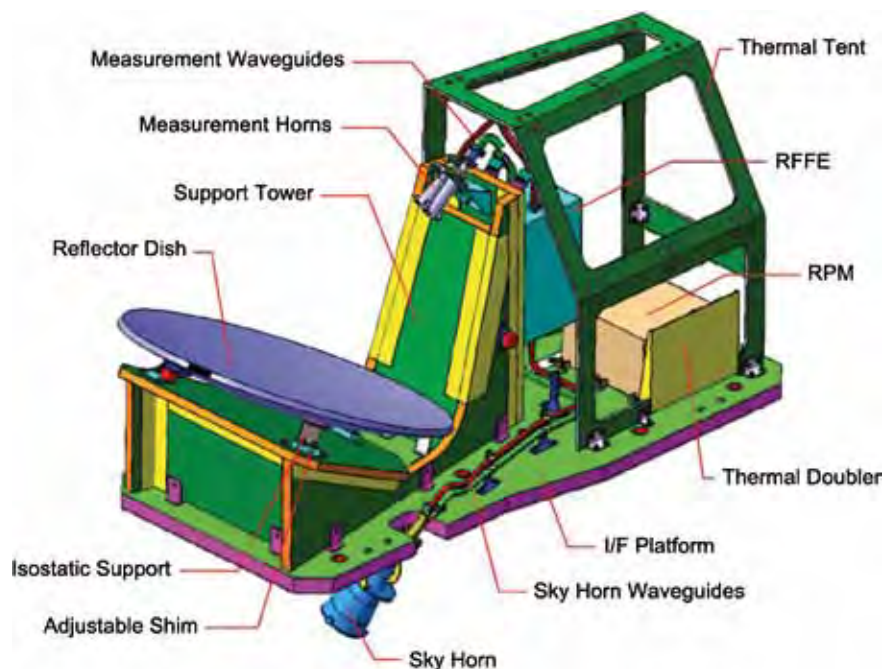

Figure 6.28. The Microwave Radiometer. (TAS-F)

## 6.5 The Precise Orbit Determination Package

Precise Orbit Determination is a prerequisite for the success of the Sentinel-3 altimetry mission. The threshold performance for near-realtime orbit determination will be 10–20 cm, with a goal of 2 cm RMS residual orbit accuracy after offline processing. For the high-accuracy orbit to be a useful accompaniment to the altimetry data used in operational ocean models, the delivery timeliness requirement will be 2–5 days.

Each of the Sentinel-3 satellites will carry a package of advanced instruments to determine its position along its orbit. In realtime, knowledge of the position is needed to point the satellite correctly towards the normal to the surface. In addition, and specifically on Sentinel-3, one of the echo-tracking modes of the altimeter (open-loop tracking) relies on *a priori* knowledge of the approximate distance between the satellite and Earth's surface. Finally, the accuracy of the topography mission measurements is directly linked to the accuracy of the knowledge of the altitude of the satellite above Earth's ellipsoid, derived offline after post-processing the POD instrument data. For the various applications, the levels of accuracy required differ by orders of magnitude: 500 m to 1 km (pointing), 0.5–3 m (open-loop tracking) and 2–3 cm (topography mission).

The POD instrumentation also provides the accurate time onboard, which is required in particular for the dating of all measurements collected by the various instruments. This time information is appended to the instrument data and is used in the ground processing to locate the data on Earth (geolocation). The instruments and equipment that form the POD package are:

- a dual-frequency, cold redundant GPS receiver, including redundant antennas;
- a DORIS receiver, consisting of an internally redundant electronics box and an antenna; and
- a Laser Retroreflector.

Although the GPS receiver has itself been designed to meet the mission requirements, it was nevertheless decided to implement a multi-instrument POD package on Sentinel-3. The addition of DORIS will thus increase the

robustness of the POD measurement system and further improve the accuracy of the topography mission, by providing measurements similar to those of the GPS receiver but based on a totally different and independent system. The Laser Retroreflector will allow the continuous validation of the reconstructed orbits on the ground, by providing single-point measurements of the range between the satellite and the laser tracking stations that form part of the International Laser Ranging Station (ILRS) ground network.

### 6.5.1 The GPS Receiver



Figure 6.29. The GPS receiver unit. (TAS-F)

The Sentinel-3 GPS receiver contributes to the satellite control, provides accurate onboard timing, controls the open-loop mode of the altimeter by providing realtime radial position data and provides the measurements for the final POD analysis. It consists of the antenna, the harness and the receiver unit itself. The main characteristics of the GPS receiver are summarised in Table 6.8.

The receiver is capable of receiving the L1 C/A, L1P(Y) and the L2P(Y) signals of the GPS constellation. It will track up to eight satellites and two signal bands in parallel. The GPS receivers on subsequent Sentinel-3 satellites will be able to track additional signals in order to adapt to the changing GPS constellation and the introduction of the Galileo system. The receiver unit is displayed in Fig. 6.29.



Figure 6.30. The two choke rings of the GPS antenna (diameter 200 mm). (TAS-F)

The small box on top of the main unit contains the diplexer that splits the two signal bands and a first low-noise amplifier. The main box contains the receiver and correlator boards, the power converters and the interface electronics. The antenna is shown in Fig. 6.30. Conceptually, it is cup antenna design, to which two choke rings have been added to optimise the multipath performance of the system at the two receive bands L1 and L2.

To meet the realtime navigation requirements, a dedicated Enhanced Navigation Solution (ENS) has been developed. In particular, a ionosphere-free combination of dual-frequency code phase measurements is employed and the filter is operated at a 1 Hz update rate allowed by the powerful LEON processor core employed in the GPS receiver. The design has been optimised to take into account satellite manoeuvres necessary for orbit maintenance, with minimum impact on the algorithmic and operational complexity. The radial performance of the ENS is displayed in Fig. 6.31. The ENS easily meets the 3 m accuracy requirement dictated by the altimeter operation.

Table 6.8. Characteristics of the Sentinel-3 GPS receiver.

Characteristic	Details
Number of parallel tracked channels	8
Dual-frequency tracking	Yes
Signals tracked	L1 C/A, L1P(Y), L2P(Y)
Frequencies	L1: 1575 MHz, L2: 1227 MHz
Mass	3.9 kg
Volume	Antenna: $\varnothing$ 200 × 87 mm Electronics box: 322 × 105 × 240 mm
Power	10 W
Realtime navigation performance	1.1 m 3D (RMS), 0.53 m radial (RMS)
Final POD performance from GPS receiver only	3 cm radial (based on simulations)
Time to first fix	Typically 5 min, max. 15 min
Update rate of realtime navigation solution	1 Hz
Enhanced onboard navigation solution	Based on dual-frequency code phase measurements
Final precise orbit determination	Based on dual-frequency carrier phase measurements (L1 C/A & L2P(Y))

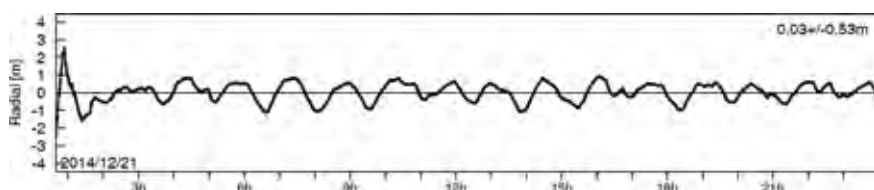

Figure 6.31. Radial accuracy of the Enhanced Navigation Solution. (DLR)

The contribution of the GPS receiver to the final POD accuracy is essentially determined by the receiver internal parameters, such as the carrier phase accuracy of the L1 and the L2 measurements. However, other external parameters, such as precise orbit and clock correction data of the GPS constellation, play an equally important role in the POD. This latter information is acquired from the International GNSS Service (IGS; [www.igs.org](http://www.igs.org)), a global system of satellite tracking stations, data storage and analysis centres that makes high-quality GPS data and data products available online for a wide range of scientific and engineering applications.

### 6.5.2 Doppler Orbitography and Radiopositioning Integrated by Satellite

DORIS is a satellite tracking system designed in the late 1980s by CNES as a new system to provide precise orbits onboard low-Earth orbit satellites.

The operation of DORIS relies on a dense global network of ground stations transmitting omnidirectional signals at a known frequency. The relative motion of a satellite with respect to the beacon(s) in view induces a shift in the frequency of this signal due to the Doppler effect, which is measured by a dedicated DORIS receiver on the satellite (Fig. 6.32). This Doppler shift is directly proportional to the radial speed of the satellite with respect to the beacon and varies during the visibility time, which lasts several minutes for each beacon. By combining this information with knowledge of the location of each beacon, it is then possible to derive the orbit of the satellite. This is done in realtime onboard by the receiver itself, which delivers navigation and time information, similar to the GPS receiver. In addition, Doppler information is also downloaded to the ground, where precise orbits are computed offline with high accuracy.

Sentinel-3 is equipped with a new-generation (multichannel and digital) receiver, developed by CNES and embarked as a Customer-Furnished Instrument (CFI). This type of receiver is also flying on Jason-2 and CryoSat-2 and is able to track up to seven beacons simultaneously. This represents a significant improvement on previous generation receivers that could track only one (e.g. on TOPEX/Poseidon and SPOT-2/3/4) or two beacons (on SPOT-5, Envisat and Jason-1) simultaneously. This feature significantly increases the quantity of DORIS measurements and consequently the quality of the data.

It is expected that the realtime accuracy of the DORIS navigation solution on Sentinel-3 will be 5–10 cm, which will allow control of the open-loop tracking mechanism of the SRAL altimeter if required. The offline POD performance is expected to be around 3 cm, although the combination of both GPS and DORIS measurements in the POD processing is expected to improve the final performance even further. The Sentinel-3 receiver consists of a single box containing two receivers and two Ultrastable Oscillators (USOs) in cold redundancy and an antenna.

The USO delivers a 10 MHz signal that is comparable with the beacon frequency received onboard. On Sentinel-3 this 10 MHz signal is also used as the master clock for the SRAL instrument. This architecture was chosen to ensure the highest possible range measurement accuracy for SRAL. The frequency of the DORIS USO is monitored by the DORIS ground segment, which can detect the slightest frequency drifts over time and provides corresponding

Figure 6.32. The DORIS antenna and main unit. (CNES)







Figure 6.36. The Laser Ranging System of the geodetic observatory in Wettzell, Bavaria. (ILRS)

of laser beams to weather conditions make it impossible to track the satellite continuously (Fig. 6.36). Therefore, this technique cannot replace the other POD instrumentation (i.e. GPS receiver and/or DORIS).





## 7. Sentinel-3 Ground Segment

The GMES Sentinel Ground Segment is in charge of the overall commanding and monitoring of the various satellite constellations as well as the acquisition, processing and dissemination of their observation data. The two primary components of the Ground Segment are the Flight Operations Segment and the Payload Data Ground Segment.

### 7.1 Flight Operations Segment

The main responsibilities of the FOS encompass satellite monitoring and control, including the execution of all platform activities and the commanding of the payload schedules. This segment includes:

- The Ground Station and Communications Network, which performs telemetry, telecommand and tracking operations within the S-band frequency. The S-band ground station used throughout all mission phases will be the ESA Kiruna terminal (complemented by additional Telemetry and Telecommand stations for LEOP and backup support).
- The Flight Operations Control Centres (FOCCs) for the LEOP and Commissioning phases, located at ESOC in Darmstadt, and for the Routine Phase, located at Eumetsat, also in Darmstadt (Fig. 7.1). Both FOCCs include the following facilities:
  - the Sentinel-3 Mission Control System supports hardware and software telecommand coding and transfer, Housekeeping Telemetry (HKT) data archiving and processing tasks essential for controlling the mission, maintaining the satellite onboard software, as well as handling of all FOCC external interfaces;
  - the Sentinel-3 Mission Scheduling System (part of the Mission Control System) supports command request handling and the planning and scheduling of satellite/payload operations;
  - the Sentinel-3 Operational Simulator supports procedure validation, operator training and the simulation campaign before each major phase of the mission; and
  - the Sentinel-3 Flight Dynamics System supports all activities related to attitude and orbit determination and prediction, preparation of slew and orbit manoeuvres, evaluations of satellite dynamics and navigation.
- A General Purpose Communication Network, which provides the services for exchanging data with any other external system during all mission phases.



Figure 7.1. The main Flight Operations Control Room at ESOC, Darmstadt, Germany.

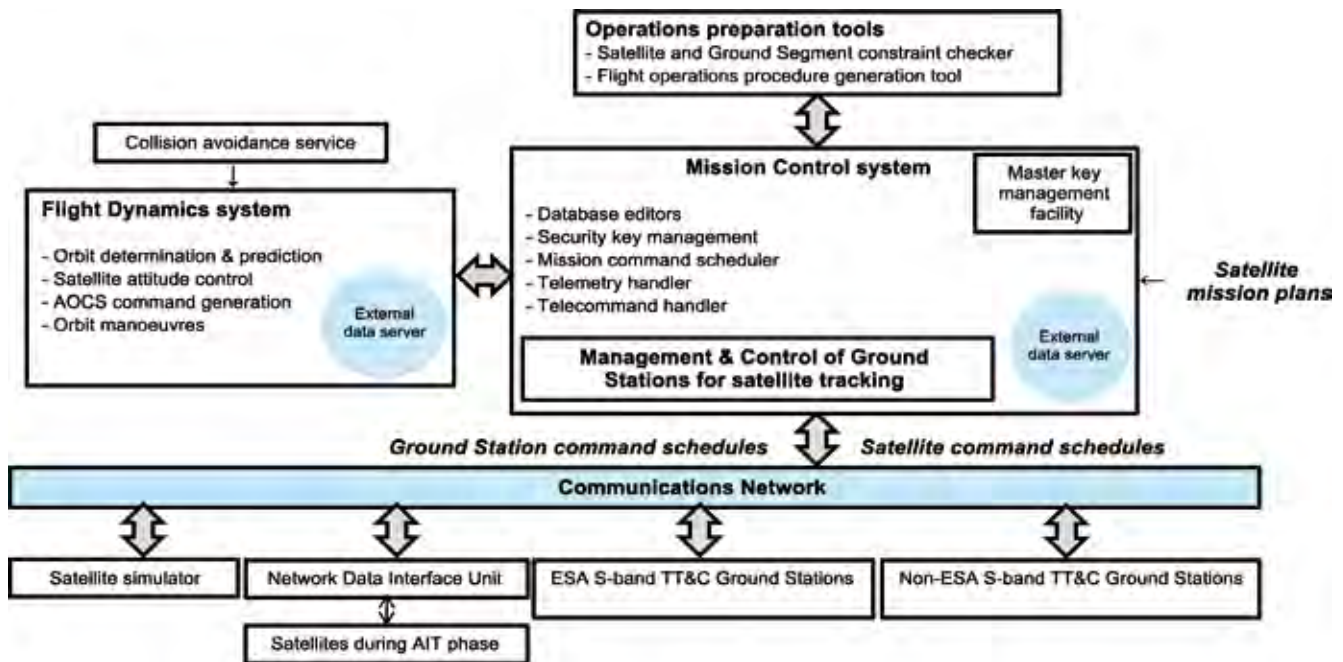

Figure 7.2. Components of the Sentinel Flight Operations Segment.

The main functions of the FOS (Fig. 7.2) include:

- planning and execution of the nominal platform operations (uploading routine AOCS telecommands, orbit manoeuvres, etc.);
- monitoring the status of the satellite and recovery from onboard contingencies;
- scheduling and executing instrument operations in such ways as to maximise the mission return;
- management of the onboard storage and command scheduling of the downlink to the prime ground station or remote acquisition facilities;
- supporting the interface with the PDGS Mission Planning Facility for payload operations planning and coordination, and for the exchange of ancillary data;
- management of TC authentication/encryption keys; and
- operational validation of and uplinking the software patches delivered by the organisations responsible for onboard software maintenance.

The FOS is also responsible for orbit maintenance activities. The orbit maintenance strategy envisaged for the Sentinel-3 satellites is based on the frozen eccentricity reference orbit control concept already applied successfully on previous Earth observation missions, i.e. the orbit is controlled such that its ground track is maintained within a certain ‘deadband’ in relation to the reference ground track.

## 7.2 Payload Data Ground Segment

The PDGS will be responsible for receiving all recorded instrument measurement data, the systematic processing, archiving and dissemination of data products to users, and for various planning and mission performance monitoring tasks. Other PDGS functions include reprocessing of data products, routine screening of all generated data, monitoring of quality parameters and long-term archiving. Finally, the PDGS will perform top-level planning of payload operations, including the generation of instrument calibration settings, and the periodic submission of instrument operations files and X-band recorded satellite HKTMs to the FOS. Specific tasks of the PDGS include:

- X-band acquisition stations and front-end processing facilities for the reception of recorded science and HKTM data;
- specific processing facilities hosting the relevant marine/land instrument processing components;
- specific mission performance monitoring and mission planning facilities;
- specific short-, medium- and long-term data storage and archiving facilities; and
- specific facilities providing support for monitoring, control and quality functions, users and data distribution services.

The PDGS is a distributed system, with separate centres for land (at ESRIN) and marine data processing (at Eumetsat). The various elements of the Sentinel-3 system and the related interfaces with operational marine and land services are shown in Fig. 7.3.

For different data-processing tasks, the PDGS has established interfaces with a number of external groups:

- The SSALTO–SALP multimission ground segment (Segment Sol multi-missions d'Altimétrie, d'Orbitographie et de Service d'Altimétrie et Localisation Précise), which will be operated under the responsibility of CNES. For the Sentinel-3 mission, SSALTO will interface with the FOS to provide command information for DORIS, and with the PDGS to receive DORIS mission raw data and provide auxiliary data for PDGS POD.
- The Data Access Ground Segment (DAS) will be the gateway between users and the Sentinel-3 Ground Segment. The DAS will forward requests from users to the PDGS and deliver the related data products generated by the PDGS. The DAS is able to manage user communities, providing access to users with different priorities, specific rules, access rights and security limitations.
- Expert teams as a privileged set of users that support the Satellite Commissioning Phase and for this reason interface with the PDGS.

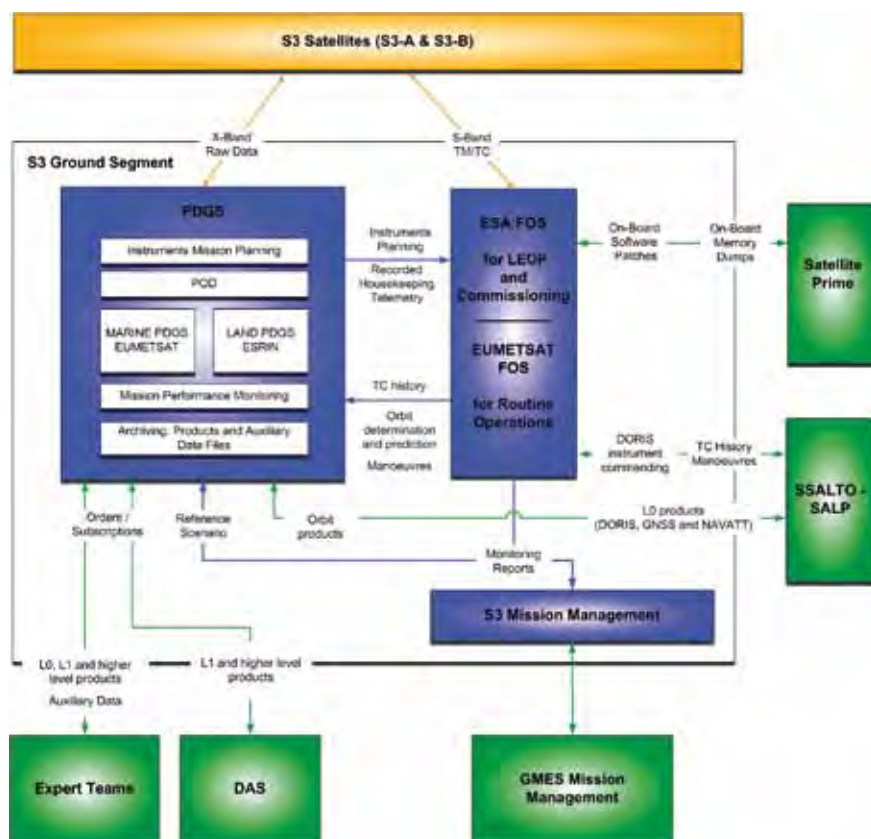

Figure 7.3. The Sentinel-3 Ground Segment system.

The Sentinel-3 satellite will be able to transmit data to the ground over two X-band channels at a rate of 280 Mbit/s per channel (260 Mbit/s actual mission data rate).

The Sentinel-3 operations concept identifies two types of X-band ground receiving station: the Core Ground Stations (CGS), which are part of the PDGS, and the Local Ground Stations (LGS), which are able to receive X-band data, typically to fulfil local needs for NRT data access. They are not part of the S-3 PDGS in the sense that no data are repatriated from the LGS back to the PDGS support mission performance objectives in terms of timeliness and processing.

GMES users will be able to access Sentinel-3 data in two ways:

- by subscription, which will result in the regular supply of newly available products according to defined datasets;
- by selecting mission products from a catalogue, which will result in a one-shot supply of the selected products via direct download or FTP.

The marine and land parts of the PDGS provide specific user interfaces for accessing Sentinel-3 products. In particular:

- marine and land web portals where the predefined datasets for these domains will be available on subscription (datasets for the atmosphere domain will be advertised on both portals); and
- marine and land catalogues where users can browse and select products and submit queries online.

## 8. Sentinel-3 Products

The suite of Sentinel-3 data products has been defined to continue the established data streams from previous missions such as Envisat and ERS, and to serve established and new GMES operational users with products suitable for routine exploitation and for assimilation by GMES service modelling systems (e.g. NOP, NWP, Climate).

### 8.1 Level-1 Processing

Level-1 processing for Sentinel-3 includes standard processing from L0 source packets to L1b radiance products (for the optical mission) and a new L1c processor providing synergetic products over land surfaces.

The data products at Level-1b include top-of-atmosphere (TOA) radiance or temperature values for the OLCI and SLSTR instruments, and echo waveforms in LRM and SAR mode for the SRAL. The products are resampled to a grid related to the satellite ground track and geolocated. For the optical instruments the geolocation considers the terrain topography (i.e. orthogeolocation). The data are quality-controlled, radiometrically calibrated, spectrally characterised, and annotated with satellite position and pointing, landmarks and preliminary pixel classification (e.g. land/water/bright-pixel mask).

Generic L1b datasets will be used at a variety of centres and institutions to develop higher-level products and applications. For example, the Sentinel-5 mission concept includes a dedicated instrument for atmospheric aerosol measurements, which is an imager with multi-angle polarimetric hyperspectral capabilities. The retrieval of atmospheric trace gas data from the Sentinel-4 and Sentinel-5P (precursor) missions will benefit from a synergistic aerosol product from the S-3 optical data in the O2A band (Thomas et al., 2007), while observations in the UV spectral band will be suitable for constraining aerosol absorption also over bright surfaces, including clouds (de Graaf et al., 2004).

Observations from two optical instruments will be operationally combined to create synergistic products that users can exploit as one 'virtual' instrument observation.

The basic synergistic product from OLCI and SLSTR TOA spectral information has been defined as Level-1c. It will include all OLCI bands and SLSTR channels from nadir and oblique views, completed by interchannel deregistration information. This deregistration dataset is defined with respect to a specific grid defined by the acquisition geometry of one of the five OLCI cameras. As it is derived from L1b data continuously acquired over ocean and land areas, physical measurements are radiometrically calibrated, orthogeolocated and completed by error estimates. The product is not resampled to a specific output projection grid but the deregistration data will allow the user to construct any desired common output grid for all spectral channels.

All Level-1 products will be distributed in near-realtime.

In order to define a common instrument grid, specific deregistration information is included to allow all spectral channels to be coregistered relative to a specific grid defined by one OLCI camera. Therefore the spatial resolution of L1c is defined by the capabilities of the OLCI with 300 m, even though the original SLSTR channels at 500 m and 1000 m spatial sampling distance are not modified. Figure 8.1 shows the relationships between the different instruments and reference grids applicable for L1c processing. Level-1c includes the individual L1b values with no further radiometric processing. Most of the L1b auxiliary data (i.e. meteorological information, quality flags) are transferred to L1c.

Figure 8.1. The OLCI and SLSTR instruments and the reference grids applicable for L1c processing.

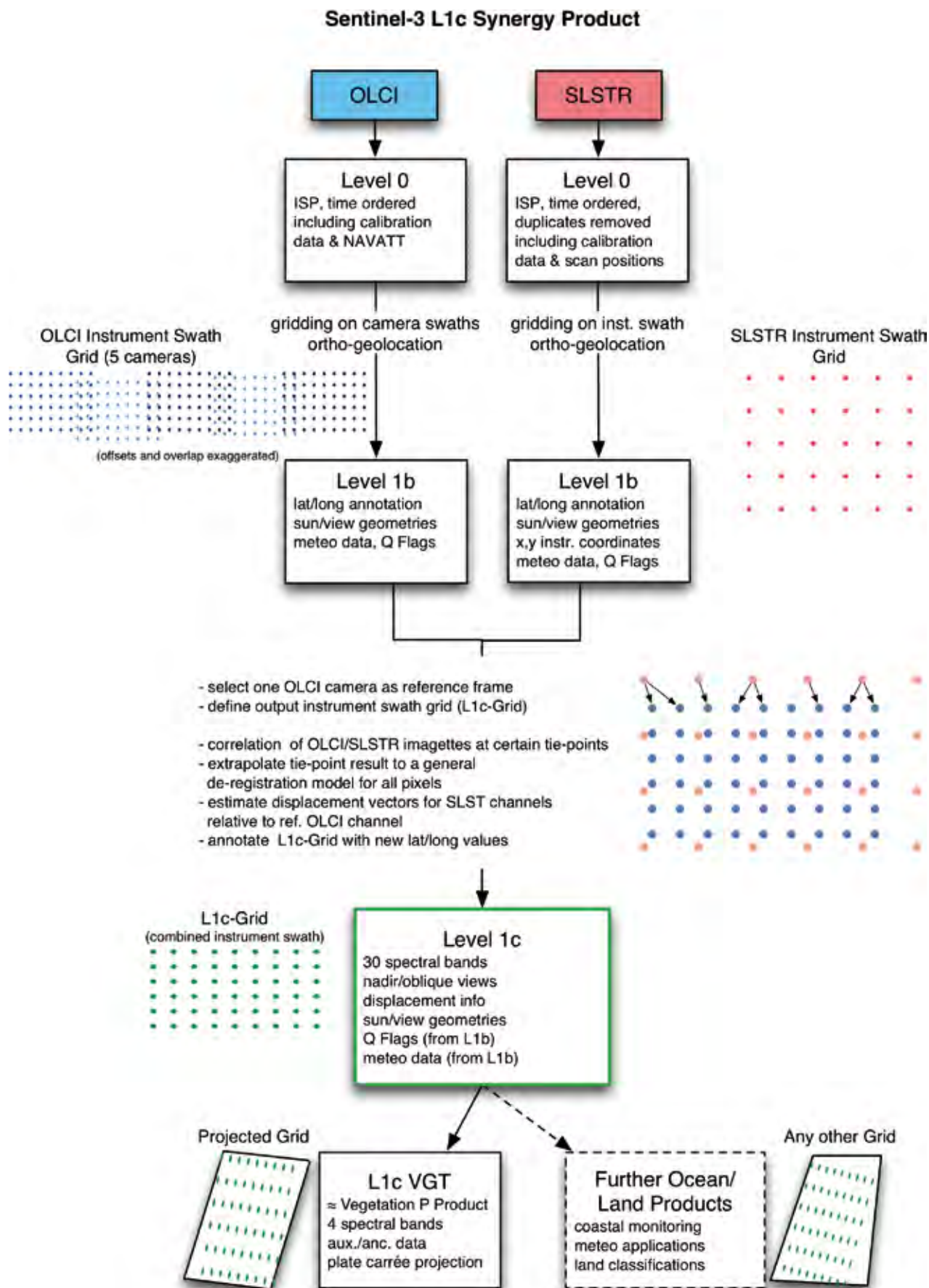

Table 8.1. Sentinel-3 Level-1 products.

Product name [PDGS Product ID]	Parameter	Parameter definition
OLCI Level-1 in Reduced and Full Resolution [OL_1_EFR] [OL_1_ERR]	TOA radiances	Radiance (in $W\ m^{-2}\ sr^{-1}\ \mu m^{-1}$ ) of 21 OLCI bands with time stamps, flags, geolocation, meteo annotation datasets
SLSTR Level-1B [SL_1_RBT]	TOA radiances	Radiance (in $W\ m^{-2}\ sr^{-1}\ \mu m^{-1}$ ) of bands S1–S3.
	TOA brightness temperatures	Brightness temperatures for bands S4–S9 (in K). All values in dual view with time stamps, flags, geolocation and meteo annotation datasets
Level-1c product (SYN-L1C)	TOA radiances	Combined OLCI and SLSTR spectral channels in acquisition geometry with necessary coregistration data
	TOA brightness temperatures	

The top-of-atmosphere L1c product is then used to create bottom-of-atmosphere reflectance values in addition to improved aerosol estimates over land surfaces.

The Sentinel-3 Level-1 products are summarised in Table 8.1.

## 8.2 Level-2 Processing

Products at Level-2 are geophysical parameters at the bottom of the atmosphere. Tables 8.2 and 8.3 show the defined ‘core’ products that will be produced by the Sentinel-3 system. Additional products may be produced as required by GMES services either in the core PDGS or as a collaborative component from external funding sources (Fig. 8.2).

Level-2 optical products include a range of geophysical quantities derived from more fundamental L1b products making use of auxiliary data (as required by L2 algorithms). Level-2 topography products include information such as the altimeter range (1 Hz and 20 Hz waveform data), orbital altitude, time, water vapour from the MWR and geophysical corrections, along with significant wave height and wind speed. A dedicated L2 preprocessed (L2P) SST data product, with the addition of a quantitative confidence value attached to every data point, will also be generated according to the specifications of the Group for High-Resolution Sea Surface Temperature (Donlon et al., 2009).

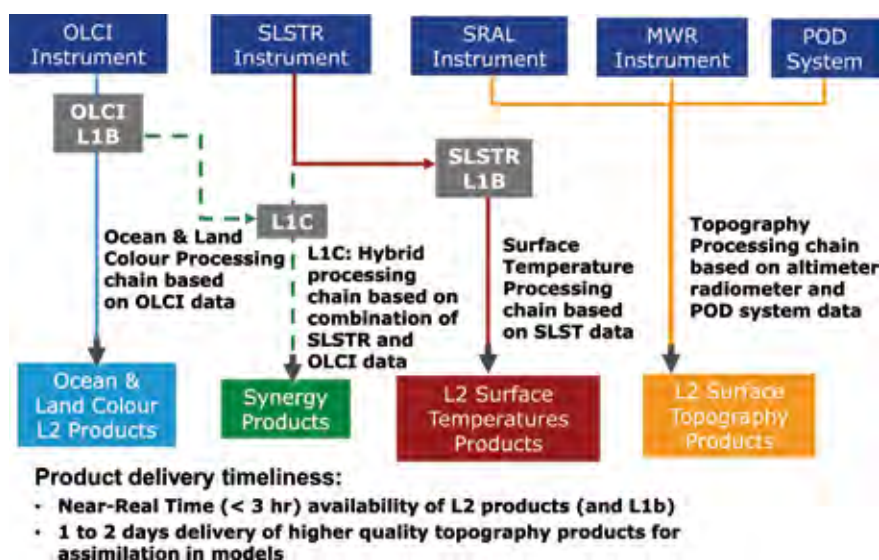

Figure 8.2. Sentinel-3 processing chains for generating ocean colour and land reflectances, land and sea temperatures, and ocean and land topography products.

Table 8.2. List of 'core' Level-2 products from the OLCI/SLSTR.

Product name [PDGS product ID]	Parameter	Parameter definition
OLCI Level-2 in Reduced and Full Resolution [OL_2_WRR] [OL_2_WFR]	Water leaving reflectance (R)	Surface directional reflectance, dimensionless, corrected for atmosphere and Sun specular reflection, at all OLCI channels except those dedicated to atmosphere absorption measurements, and associated error estimates
Ocean colour products [OL_2_WRR] [OL_2_WFR]	Algal pigment concentration 1 (Chl-1)	Chlorophyll-a concentration in Case 1 waters and associated error estimates (in $\text{mg m}^{-3}$ )
	Algal pigment concentration 2 (Chl-2)	Chlorophyll-a concentration in Case 2 waters and associated error estimates (in $\text{mg m}^{-3}$ )
	Total Suspended Matter concentration (TSM)	Total suspended matter concentration, and associated error estimates (in $\text{g m}^{-3}$ )
	Diffuse Attenuation coefficient (Kd)	Diffuse attenuation coefficient for downwelling irradiance, and associated error estimates (expressed in $\text{m}^{-1}$ at 490 nm)
	CDM absorption coefficient (CDOM)	Absorption of Coloured Detrital and Dissolved Material, and associated error estimates (expressed in $\text{m}^{-1}$ at 443 nm)
Atmosphere product [OL_2_WRR] [OL_2_WFR]	Photosynthetically Active Radiation (PAR)	Quantum energy flux from the Sun in the spectral range 400–700 nm and associated error estimates (in $\text{Einstein/m}^2/\text{day}$ )
	Aerosol Optical Depth over Water (AOD-W)	Aerosol load, expressed in optical depth at a given wavelength (865 nm), and associated error estimates
	Aerosol Ångström Exponent over Water (AAE-W)	Spectral dependency of the aerosol optical depth between 779 nm and 865 nm, and associated error estimates.
	Integrated Water Vapour (IWV) column	Total amount of water vapour integrated over an atmosphere column, and associated error estimates ( $\text{kg m}^{-2}$ )
OLCI Level-2 land products [OL_2_LRR] [OL_2_LFR]	OLCI Global Vegetation Index	Fraction of Absorbed Photosynthetically Active Radiation (FAPAR) in the plant canopy
	Red and NIR rectified reflectances	By-product of FAPAR estimate, defined as 'virtual' reflectance at 681 nm and 685 nm largely decontaminated from atmospheric and angular effects, and a good proxy for the Top of Canopy reflectance
	OLCI Terrestrial Chlorophyll Index	Estimates of the chlorophyll content in terrestrial vegetation, for monitoring vegetation condition and health
	Integrated Water Vapour columns	Same as in OLCI_L2_WFR, but estimated over land surfaces
Level-2 SST [SL_2_WST]	Sea Surface skin Temperature (SST)	Stand-alone product conforming to the GHRSSST L2P specification, containing a composite 'best SST' field, error estimates and contextual auxiliary data fields, SST (in K) and various other units. Note: intermediate SST estimates (D2/D3/N2/N3 SST <sub>skin</sub> products) are produced but not distributed
Level-2 LST [SL_2_LST]	Land Surface Temperature (LST)	Single view, two-channel land surface temperatures (in K), associated error estimates, exception flags, and contextual information Ancillary data: NDVI, GlobCover classification, fractional vegetation cover
Level-2 product + aerosol parameter [SY_2_SYN]	Surface Reflectance	Fully atmosphere-corrected surface reflectance and associated error estimates. Synergistically retrieved from OLCI channels and SLSTR channels (both nadir and oblique views), except for gaseous absorption channels
	Aerosol Optical Depth over land (AOD-L)	Aerosol load, expressed in optical depth at a given wavelength (550 nm), and associated error estimates
	Aerosol Ångström Exponent over land (AAE-L)	Spectral dependency of the aerosol optical depth derived from 40 aerosol models, and associated error estimates
Vegetation [SY_2_VGP/VG1/V10]	VGT P-Product (VGT-P) VGT S1-Product (VGT-S1) VGT S10-Product (VGT-S10)	TOA radiances and vegetation indices composites for 1 and 10 days



Table 8.3. Level-2 products for SRAL.

Product name [PDGS product ID]	Parameter	Parameter description
SRAL Level-1b [SR_1_SRA] [SR_1_CAL]	Radar echoes, single waveform $\sigma^0$ values in LRM mode Radar echoes $\sigma^0$ values in SAR mode	20 Hz data in Ku- and C-bands, instrument and geophysical corrections applied Note: calibration measurements (SR_1_CAL) are distributed as a separate product
Level-2 marine product Ocean and sea ice areas [SR_2_WAT]	Elevation values (R) Backscattering coefficient Sea Surface Height anomaly (SSHA) Significant Wave Height (SWH) Wind speed (WS)	All parameters are provided for LRM and SAR mode in one product
	Sea ice freeboard	Height of sea ice floes above sea surface
	Sea ice sea surface height	Height of the sea surface in sea ice areas with respect to a reference datum
	Sea ice surface height anomaly	Variations in the height of the sea surface with respect to a mean sea surface (m)
Level-2 land product [SR_2_LAN]	Elevation values (R) Surface height	As baseline acquisitions over land is always in SAR mode No specific land algorithms are used for the land product Note: Surface heights must be computed by the user: range, orbit, geophysical corrections

### 8.3 Calibration and Validation

Sentinel-3 Calibration and Validation (Cal/Val) activities are essential to the quality of the mission. Data quality will be assessed through determination of the radiometric, spatial, spectral and geometric fidelity of the satellite sensor and the accuracy of geophysical products. Three phases of calibration and validation are foreseen:

- Prelaunch Phase instrument characterisation and on-ground calibration.
- A Commissioning Phase (E1) lasting ~5 months will be performed for Sentinel-3A, in which all instrument operation aspects will be verified and in-orbit Cal/Val activities will be initiated. Instrument data should be available from ~1 month after launch for initial tests and engineering commissioning verification, calibration and validation activities (Fig. 8.3). Building on the experience of Sentinel-3A, a slightly shorter E1 phase (~3 months) is planned for Sentinel-3B.
- An Exploitation Phase (E2) will then commence, extending for the duration of the mission, in which Cal/Val activities will continue for geophysical data products.

Dedicated Sentinel-3 calibration tasks include:

- full prelaunch characterisation and calibration of all instruments;
- full in-flight calibration and (re)characterisation of all instruments;
- comprehensive verification of Level-1 data processors (tuning of all relevant processing parameters, regeneration of all L1 auxiliary products); preparation and advice for necessary Level-1 processor updates; and
- routine calibration monitoring and assessment after the end of the Commissioning Phase.

Figure 8.3. Testing of the Engineering Model of an OLCI camera (COSA, FPA, CCD and VAM) and validation of the test bench. (TAS-F)

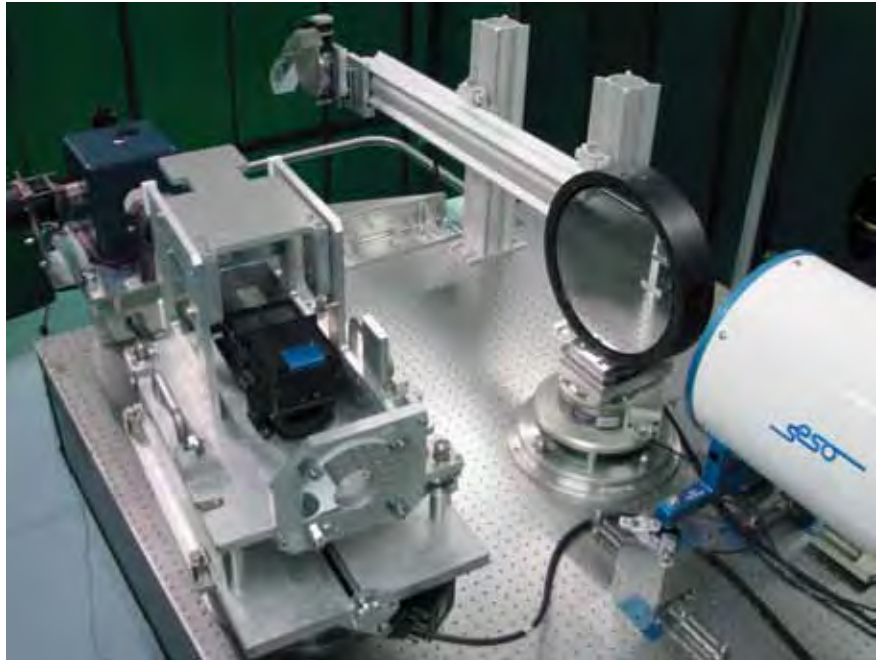

Dedicated Sentinel-3 validation tasks include:

- Level-2 algorithm validation starting during the Commissioning Phase and continued throughout Phase E2;
- quantification of L1 and L2 product error estimates; and
- long-term monitoring for consistency and constant quality of geophysical products.

In addition, the calibration and validation component of the Sentinel-3 mission will include maintenance and evolution of prototype ground processors, generation of all prelaunch auxiliary datasets needed for L1 and L2 processing, convening and managing dedicated calibration and validation teams, detailed Commissioning Phase planning with the definition of interfaces to all processing and support centres, and the definition and planning of *in situ* campaigns to be conducted during the Commissioning Phase. Ongoing operations will include monitoring and maintenance of all uncertainty estimates and may require additional activities to maintain the quality of Sentinel-3 data products. Sentinel-3 Cal/Val plans and activities will be consolidated prior to launch and will be reviewed and updated on a regular basis as required by the mission. In particular, a PDGS reprocessing capability will support calibration and validation activities as well as potential tuning of algorithms and product evolution.

## 8.4 Satellite Commissioning

The Sentinel-3 Commissioning Phase starts after the Prelaunch Phase and ends with the In-Orbit Commissioning Review (IOCR), and includes three subphases (see Fig. 8.4):

- the Launch and Early Orbit Phase (LEOP);
- the Satellite (and instruments) In-Orbit Verification (SIOV); and
- the instrument calibration and initial operational products validation activities.

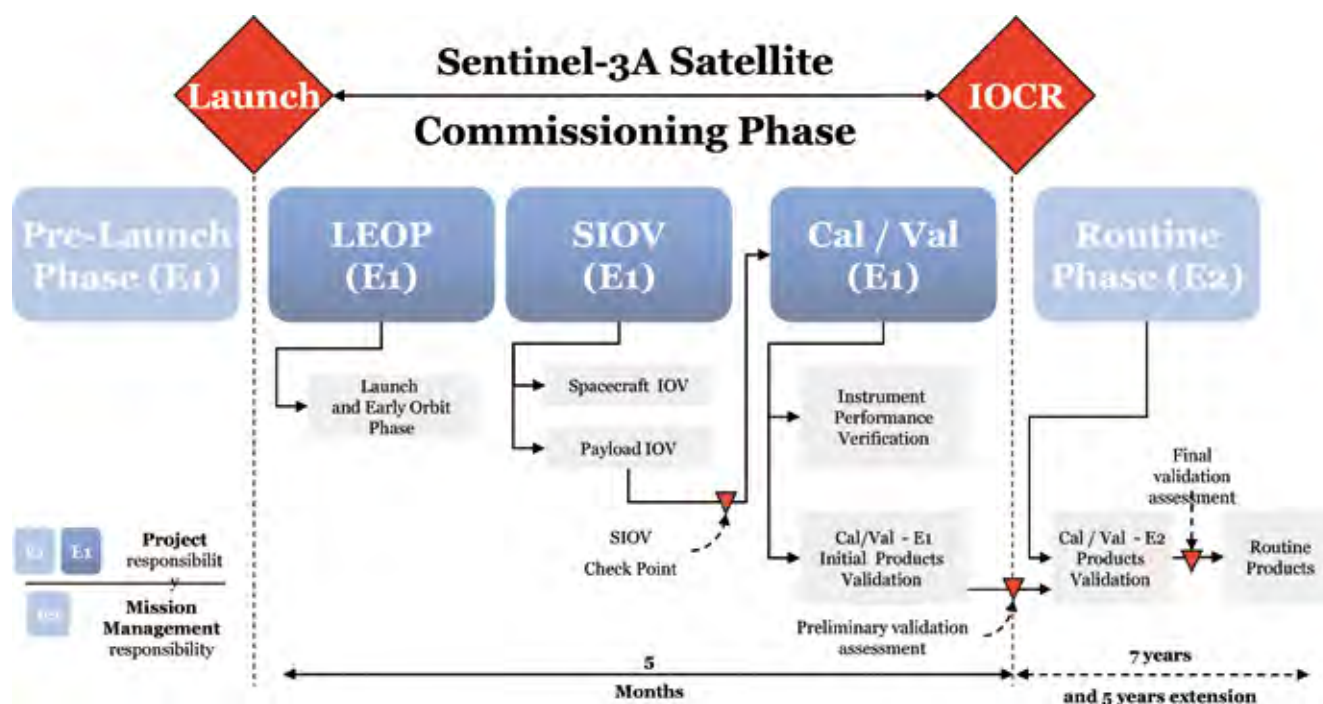

Figure 8.4. The Sentinel-3 Commissioning Phase.

The nominal duration of the Sentinel-3A mission Commissioning Phase is 5 months.

The Prelaunch Phase, although not regarded as a real ‘mission’ phase, is intended to cover the launch campaign activities performed on the Sentinel-3 satellite after its acceptance at the Flight Acceptance Review (FAR) until liftoff. This period covers the last preparatory activities at the integrator site and the preparatory activities at the launch site.

During LEOP the satellite is launched and injected into the correct orbital plane. The nominal duration of this phase is three days, during which the satellite pointing is adjusted, the solar array is deployed and all systems and instruments are powered on and checked.

The SIOV is intended to verify that the satellite is operable through all specified modes of operation, and its functional performance in orbit is consistent with that measured on ground (Fig. 8.5).

At the end of the SIOV phase, it is verified that the satellite and its instruments are operable (commandability and observability through housekeeping telemetry). It is further verified that the mission data are being transmitted correctly and acquired at the Ground Segment side.

The SIOV will be followed by the Cal/Val phase (see section 8.3), which is planned to continue for 120 days (4 months). Finally, the Commissioning Phase will conclude with the In-orbit Commissioning Review. At this milestone the Operational Phase is initiated by mission management and the ground segment centres in ESRIN and Eumetsat. The nominal duration of the Sentinel-3A Operational Phase is specified as 7 years. In terms of the sizing of the different Space and Ground Segment elements, a maximum of 12 years of operation is being considered.

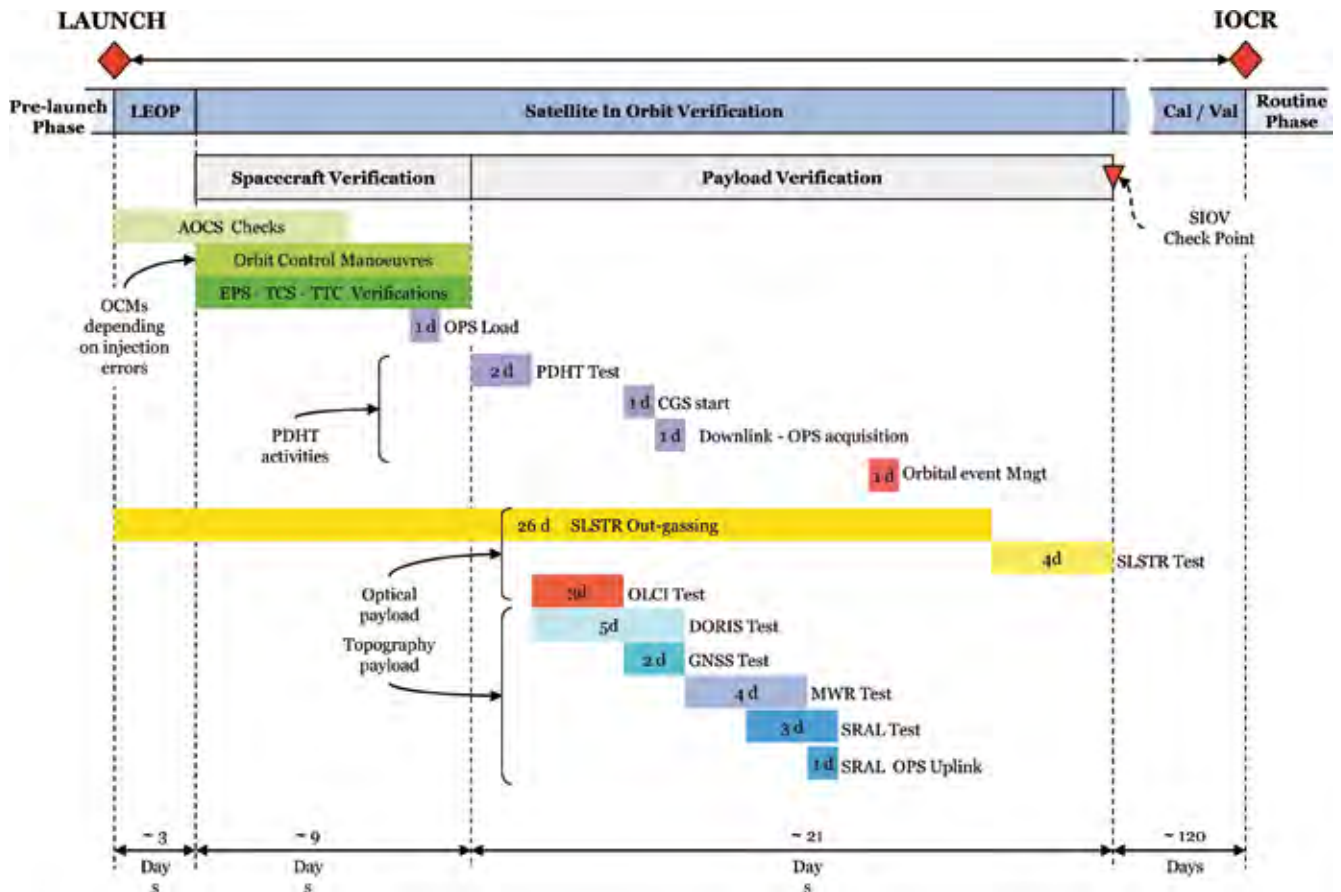

Figure 8.5. Satellite In-Orbit Verification.

## 9. Conclusions

Sentinel-3 has been designed to provide routine, long-term and continuous Earth observation data products with a consistent quality and a very high level of availability to support GMES Marine, Land, Atmospheric, Safety, Security and Climate Services. In order to meet GMES user needs, the Sentinel-3 satellite data will generate in an operational system high-level geophysical products with a consistent quality. The mission is also designed provide continuity to SPOT/Vegetation-like products to meet GMES user needs.

Considering a long-term perspective, the sustained measurement systems of Sentinel-3 within the GMES framework may ultimately lead to improved long-range ocean, biogeochemical and atmospheric forecasts and land monitoring capabilities based on new technology and new understanding of the marine, land, atmospheric and cryospheric environments. GMES is providing the foundations for such a framework in which environmental information is gathered and processed into accurate high-quality information products and services tailored to the needs of decision makers. In an operationally robust and sustained near-realtime system, Sentinel-3 will provide policy makers and public authorities within GMES with state-of-the-art Earth observation information to enable them to take decisions with confidence, prepare environmental legislation and policies, monitor their implementation and assess their socio-economic impacts and benefits.



**→ APPENDICES**





## Appendix: Sentinel-3 Industrial Consortium

Satellite Prime Contractor	Thales Alenia Space (France)
OLC Mission expertise	ACRI-ST (France)
Topography Mission expertise support	CLS (France)
SLST Mission expertise support	Rutherford Appleton Laboratory (UK)
Mission analysis	Deimos (Spain)
Schedule/documentation/configuration	VEGA
AOCS engineering support	NCG (Canada)
Support to PA activities	Alter (Spain), Altior (Portugal), Thales Alenia Space España (Spain)
O-SPS scene generator	Vista (Germany)
CPPA	Alter (Spain)
PA software	ETIQ (Germany)
Support to satellite engineering	Altran (Sweden)
O-GPP	Deimos (Spain)
SRAL GPP	Isardsat (Spain)
MWR GPP	Deimos (Portugal)
GPS GPP & SPS	GMV (Spain)
Support to validation	Skysoft (Portugal)
Satellite reference database	Altran (Luxembourg)
MGSE	AMOS (Belgium), Assystem (France)
ISVV	Deimos (Spain)
Central software	Critical Software (Portugal)
AOCS SCOE	Studiel UK (UK)

Platform Prime Contractor/System Engineering Support	Thales Alenia Space (Italy)
Battery	ABSL (UK)
PDHU	Astrium GmbH (Germany)
PCDU	Thales Alenia Space ETCA (Belgium)
Structure	RUAG (Switzerland)
TXA	Thales Alenia Space España (Spain)
SBT	Thales Alenia Space España (Spain)
Thermal control	EADS Casa Espacio (Spain)
SADM	Kongsberg (Norway)
Solar Array Wings	Thales Alenia Space (France)
SBA	RUAG (Sweden)
XBAA	Thales Alenia Space (Italy)
PDHT EGSE	Vitrociset (Italy)
TMTC DFE	SSBV (Netherlands)
1553 SCOE	Techno System Development (Italy)
TTC SCOE	Siemens (Austria)
Pyro Power SCOE	Thales Alenia Space ETCA (Belgium)
MGSE	Active Space Technologies GmbH (Germany)
Platform harness	RYMSA (Spain)
Platform DC & pyro harness	Altran (Germany)
OLCI Prime Contractor	Thales Alenia Space (France)
CCD	E2V (UK)
Detection chain architecture	Thales Alenia Space España (Spain)
Camera Optical Sub-Assembly	EADS SODERN (France)

FPA/VAM	Thales Alenia Space (Italy)
Thermal control support	Altran (Luxembourg)
Calibration mechanisms & HW	CSL (Belgium)
OEU	Thales Alenia Space España (Spain)
Scrambling window assembly	TNO (Netherlands)
EGSE camera OLCI	Rovsing (Denmark)
STCA	APCO (Switzerland)
Instrument EGSE	Rovsing (Denmark), Clemessy (Switzerland)
Support to OLCI engineering	Assystem (France)
SWA	EADS SODERN (France)
EGSE	AUSY (Belgium)
Support to AIT	Studiel UK (UK)
Harness	BTS (France)
OGSE	Various companies
MGSE	Avantis (France)
RIS simulator monitoring	Lusospace (Portugal)
Sun simulator refurbishment	SESO (France)
SRAL Prime Contractor	Thales Alenia Space (France)
RFU Boards	Thales Alenia Space (France)
SRAL EGSE PTF S/S	SSBV (Netherlands)
SRAL PSU C & Ku band	Thales Alenia Space ETCA (Belgium)
SRAL RFU C-band duplexer	Chelton (France)
SRAL EGSE RF S/S	RUAG (Austria)
SRAL RFU Ku-band duplexer	COMDEV (UK)
RFU DC/DC converter	CAEN (Italy)
DC/DC, DPU/RFU boards manufacturing	Syderal (Switzerland)
Antenna S/S	MDA (Canada)
EGSE digital S/S	ISIS (France)
EGSE measurement S/S	Assystem Iberia (Spain)
C-band switch	Radiall (France)
Ku-band switch	Tesat (Germany)
DC harness	BTS (France)
MGSE	Avantis (France)
RF harness	Various companies
MWR Prime Contractor	EADS CASA (Spain)
REU	Thales Alenia Space España (Spain)
RFFE	Thales Alenia Space (Italy)
RPM	EADS CRISA (Spain)
MGSE	APCO (Switzerland)
EGSE	HV Sistemas (Spain)
Calibration targets	ABSL (UK)
Harness	ITD (Spain)
Test facilities	IABG (Germany)
SLSTR Prime Contractor	Selex Galileo (Italy)
Opto-Mechanical Enclosure	Jena-Optronik (Germany)
Black body S/S & temperature measurement electronics	ABSL (UK)
Visible calibration unit	TNO (Netherlands)
Structure	MKE (Germany), CFT (Germany), Jena-Optronik (Germany), Thales Alenia Space (France)
Parabolic mirror	SESO (France)
Multilayer insulation	RUAG (Austria)

EGSE	HV Sistemas (Spain)
FMC/FMD	Sener (Spain)
OGSE collimator	Trioptics (Germany)
OME MGSE	Jena-Optronik (Germany)
Scan mirror/scan drive components	Jena-Optronik (Germany)
Thermal HW	Iberespacio (Spain)
External test facilities	IABG (Germany)
Calibration engineering & tests	Rutherford Appleton Laboratory (UK)
IR detector units	AIM (Germany)
SLCPE	EADS CRISA (Spain)
Cryocooler S/S	Astrium (UK)
SLSTR visible detectors	OSI (Norway)
Avionics	Thales Alenia Space (France)
<i>In situ</i> SVF simulation SW	Rovsing (Denmark)
Virtual EM realtime SW	TCP (Spain)
GNSS	RUAG (Austria)
StarTracker	EADS SODERN (France)
MAG	Lusospace (Portugal)
SMU	RUAG (Sweden)
Coarse sun sensor	TNO (Netherlands)
Latch valve	RTG (Germany)
Tank	MT-SP (UK)
Coarse rate sensor	SELEX Sensors (UK)
Thrusters	AMPAC (UK)
Virtual EM HW elements	Clemessy (Switzerland)
SVF SMU simulator model development	ETIQ (Germany)
MTB	Tamam (Israel)
Reaction wheel assembly	RCD (German)
FDV	AMPAC (UK)
SAPT	Bradford (Netherlands)
Filters	Sofrance (France)
VEM LVDS PC	ADAS Lorin (France)
VCF VEM	Astek (Switzerland)
Support to validation	Skysoft (Portugal)



## References

- Bahurel, P., et al. (2010). *Ocean monitoring and forecasting core services, the European MyOcean Example*. In J. Hall, D. E. Harrison, & D. Stammer (Eds.), Proceedings of OceanObs'09: Sustained Ocean Observations and Information for Society, Venice, Italy, 21–25 September 2009, Vol. 1, ESA WPP-306. doi:10.5270/OceanObs09.pp.02.
- Bonekamp, H., Bonnefond, P., Donlon, C., Lillibridge, J., Willis, J., von Englen, A. & d'Addio, S. (2012). *JASON Continuity of Service Mission Requirements Document*. EUM/LEO-JASCS/REQ/11/0002 (available from Eumetsat).
- Coppo, P., Ricciarelli, B., Brandani, F., Delderfield, J., Ferlet, M., Mutlow, C., Munro, G., Nightingale, T., Smith, D., Bianchi, S., Nicol, P., Kirschstein, S., Hennig, T., Engel, W., Frerick, J. & Nieke, J. (2010). SLSTR: A high accuracy dual scan temperature radiometer for sea and land surface monitoring from space. *J. Mod. Optics* **57**, 1815–1830.
- Cotton, D., Allan, D., Ménard, Y., Le Traon, P.Y., Cavaleri, L., Doornbos, E. & Challenor, P. (2004). *GAMBLE : Requirements for Future Satellite Altimetry. Recommendations for Missions and Research Programmes*. Contact report EVR1-CT-2001-20009. Thematic Network. Global Altimeter Measurements by Leading Europeans, EC Framework 5. [www.altimetrie.net](http://www.altimetrie.net)
- De Graaf, L.G. Tilstra, and P. Stammes, (2004). SCIAMACHY Absorbing Aerosol Index: The scientific product compared to the operational product and TOMS data, *Proc. of the Second ACVE-2 Workshop*, ESA SP-562. European Space Agency, Noordwijk, the Netherlands.
- Donlon, C. J. (2011). *The Sentinel-3 Mission Requirements Traceability Document (MRTD)*, version 1. EOP-SM/2184/CD-cd. European Space Agency, Noordwijk, the Netherlands. [http://download.esa.int/docs/EarthObservation/GMES\\_Sentinel-3\\_MRTD\\_Iss-1\\_Rev-0-issued-signed.pdf](http://download.esa.int/docs/EarthObservation/GMES_Sentinel-3_MRTD_Iss-1_Rev-0-issued-signed.pdf)
- Donlon, C., Berruti, B., Buongiorno, A., Ferreira, M-H., Féménias, P., Frerick, J., Goryl, P., Klein, U., Laur, H., Mavrocordatos, C., Nieke, J., Rebhan, H., Seitz, B., Stroede, J. & Sciarra, R. (2012). The Global Monitoring for Environment and Security (GMES) Sentinel-3 Mission, *Remote Sensing of the Environment*, **120**, 27-57, <http://dx.doi.org/10.1016/j.rse.2011.07.024>.
- Donlon, C.J., Casey, K.S., Robinson, I.S., Gentemann, C.L., Reynolds, R.W., Barton, I., Arino, O., Stark, J., Rayner, N., LeBorgne, P., Poulter, D., Vazquez-Cuervo, J., Armstrong, E., Beggs, H., Llewellyn Jones, D., Minnett, P.J., Merchant, C.J. & Evans, R. (2009). The GODAE High-Resolution Sea Surface Temperature Pilot Project (GHRSSST-PP). *Oceanography* **22**(3), 34–45.
- Drinkwater, M. & Rebhan, H. (2007) *Sentinel 3 Mission Requirements Document*, EOP-SMO/1151/MD-md. European Space Agency, Noordwijk, the Netherlands.
- EC (2005) *GMES: From Concept to Reality*. Communication from the Commission to the Council and the European Parliament, COM(2005) 565 Final. European Commission, Brussels, Belgium. <http://ec.europa.eu/gmes/pdf/COM-2005-565-final.pdf>
- ESA (2012a). *Sentinel-1: ESA's Radar Observatory Mission for GMES Operational Services*. ESA SP-1322/1. European Space Agency, Noordwijk, the Netherlands.
- ESA (2012b). *Sentinel-2: ESA's Optical High-Resolution Mission for GMES Operational Services*. SP-1322/2. European Space Agency, Noordwijk, the Netherlands.
- Edwards., T., Browning, R., Delderfield, J., Lee, D.J., Lidiard, K.A., Milborrow, R.S., McPherson, P.H., Peskett, S.C., Toplis, G.M., Taylor, H.S., Mason, I., Mason, G., Smith, A. & Stringer, S. (1990). The Along Track Scanning Radiometer: Measurement of sea-surface temperature from ERS-1. *J. Brit. Interplanetary Soc.* **43**, 160.
- Escudier, P. & Fellous, J.-L. (2006). *The Next 15 years of Satellite Altimetry*. Ocean Surface Topography Constellation User Requirements Document, CEOS. [www.ceos.org/images/OST/SatelliteAltimetryReport\\_2009-10.pdf](http://www.ceos.org/images/OST/SatelliteAltimetryReport_2009-10.pdf)

- EU (2010). Regulation (EU) no. 911/2010 of the European Parliament and of the Council of 22 September 2010 on the European Earth monitoring programme (GMES) and its initial operations (2011 to 2013). <http://eur-lex.europa.eu/LexUriServ/LexUriServ.do?uri=OJ:L:2010:276:0001:0010:en:pdf>
- Gao, B.-C., Goetz, A.F.H. & Wiscombe, W.J. (1993). Cirrus cloud detection from airborne imaging spectrometer data using the 1.38 mm water vapor band, *Geophys. Res. Lett.* **20**, 301–304.
- Gentemann, C.L., Minnett, P.J., LeBorgne, P. & Merchant, C.J. (2008). Multi-Satellite Measurements of large diurnal SST warming events, *Geophys. Res. Lett.* **356**, L22602.
- GlobAerosol (2009). *Final Report to ESA*. GMV, GMV-GLOBAER-TN-004.
- GMES-MACC (2010). Monitoring Atmospheric Composition and Climate (MACC) project homepage. <http://www.gmes-atmosphere.eu/>
- Kay, S., Hedley, J.D. & Lavender, S. (2009). Sun glint correction of high and low spatial resolution images of aquatic scenes: A review of methods for visible and near-infrared wavelengths, *Rem. Sens.* **1**, 697–730.
- Langen, J. (2007). Mission Requirements Document Sentinel 4 & 5. EOP-SMA/1507/JL-dr.
- Llewellyn-Jones, D.T., Minnett, P.J., Saunders, R.W., & Zavody, A.M. (1984). Satellite multichannel infrared measurements of the sea surface temperature of the N.E. Atlantic Ocean using AVHRR/2. *Q. J. R. Meteorol. Soc.* **110**, 613–631.
- Pacholczyk, P., Lacaze R., Smets, B. & Freitas, S.C. (2011). Operational delivery of biophysical products and services for GMES Land Monitoring Core Service. *Proc. 34th Int. Symposium on Remote Sensing of the Environment*, Sydney, Australia.
- Ryder, P. (2007). *GMES Fast Track Marine Core Service Strategic Implementation Plan*, Final Version, 24 April 2007, Marine Core Service Implementation Group. [www.gmes.info/pages-principales/library/implementation-groups/marine-core-service-mcs/](http://www.gmes.info/pages-principales/library/implementation-groups/marine-core-service-mcs/)
- TEMIS (2012). Tropospheric Emission Monitoring Internet Service, [www.temis.nl](http://www.temis.nl)
- Thomas, G.E., Poulsen, C.A., Curier, R.L., De Leeuw, G., Marsh, S.H., Carboni, E., Grainger, R.G. & Siddans, R. (2007). Comparison of AATSR and SEVIRI aerosol retrievals over the Northern Adriatic. *Q. J. R. Meteorol. Soc.* **133**(Suppl. 1), 85–95.
- Zhang, H.M., Reynolds, R.W., Lumpkin, R., Molina, R., Zayus, R., Johnson, M. & Smith, T.M. (2009). An integrated global observing system for sea surface temperature using satellites and *in situ* data. *Bull. Am. Meteorol. Soc.* **90**(1), 31–38.
- Wooster, M. Roberts, J.G. Perry, G.L.W. & Kaufman. Y.J. (2005). Retrieval of biomass combustion rates and totals from fire radiative power observations: FRP derivation and calibration relationships between biomass consumption and fire radiative energy release. *J. Geophys. Res.* **110**, D24311.

## Acronyms and Abbreviations

<b>AATSR</b>	Advanced Along-Track Scanning Radiometer	<b>ESTEC</b>	European Space Research and Technology Centre
<b>AIT</b>	Assembly, Integration and Test	<b>EU</b>	European Union
<b>AOCS</b>	Attitude and Orbit Control System	<b>Eumetsat</b>	European Organisation for the Exploitation of Meteorological Satellites
<b>AOD</b>	Aerosol Optical Depth		
<b>AMSR-E</b>	Advanced Microwave Scanning Radiometer for EOS	<b>fAPAR</b>	Fraction of Absorbed Photosynthetically Active Radiation (FP7)
<b>APID</b>	Application Identifier	<b>FAR</b>	Flight Acceptance Review
<b>APS</b>	Active Pixel Sensors	<b>FDIR</b>	Fault Detection Isolation and Recovery
<b>AVHRR</b>	Advanced Very High Resolution Radiometer	<b>FDV</b>	Fill and Drain Valve
		<b>FFT</b>	Fast Fourier Transform
<b>Cal/Val</b>	Calibration and Validation	<b>FM</b>	Flight Model
<b>CCD</b>	Charge-Coupled Device	<b>FOCC</b>	Flight Operations Control Centre
<b>CCSDS</b>	Consultative Committee for Space Data Systems	<b>FOS</b>	Flight Operations segment
<b>CDOM</b>	Coloured Dissolved Organic Material	<b>FP</b>	Framework Programme (EC)
<b>CFI</b>	Customer-Furnished Instrument	<b>FPA</b>	Focal Plane Assembly
<b>CFRP</b>	Carbon-Fibre-Reinforced Plastic		
<b>CGS</b>	Core Ground Station	<b>GCM</b>	General Circulation Model
<b>Chl</b>	Chlorophyll	<b>GCOS</b>	Global Climate Observing system
<b>CL</b>	Closed loop	<b>GMES</b>	Global Monitoring for Environment and Security
<b>CM</b>	Calibration Mechanism	<b>GNSS</b>	Global Navigation Satellite System
<b>CNES</b>	Centre National d'Etudes Spatiales	<b>GOOS</b>	Global Ocean Observing System
<b>COSA</b>	Camera Optics Subassembly	<b>GPS</b>	Global Positioning System
<b>CSW</b>	Central Software	<b>GSC</b>	GMES Space Component
<b>CZCS</b>	Coastal Zone Colour Scanner	<b>GSE</b>	GMES Service Elements
		<b>GSRD</b>	Ground Segment System Requirements Document
<b>DA</b>	Detection Assembly		
<b>DAS</b>	Data Access Ground Segment	<b>HKTM</b>	Housekeeping Telemetry
<b>DC</b>	Direct Current	<b>HPBW</b>	Half-Power Beamwidth
<b>DEM</b>	Digital Elevation Model		
<b>DORIS</b>	Doppler Orbitography and Radiopositioning Integrated by Satellite	<b>IDS</b>	International DORIS Service
<b>DPM</b>	Digital Processing Module	<b>IGS</b>	International GNSS Service
<b>DPU</b>	Digital Processing Unit	<b>ILRS</b>	International Laser Ranging Service
		<b>IOCR</b>	In-Orbit Commissioning Review
<b>EC</b>	European Commission/European Community	<b>IR</b>	Infrared
<b>ECMWF</b>	European Centre for Medium-Range Weather Forecasts	<b>IRS</b>	Indian Remote Sensing Satellite
<b>ECV</b>	Essential Climate Variable	<b>IST</b>	Ice Surface Temperature
<b>EEPROM</b>	Electrically Erasable PROM	<b>IWV</b>	Integrated Water Vapour
<b>EM</b>	Engineering Model		
<b>ENS</b>	Enhanced Navigation Solution	<b>Jason-CS</b>	Jason Continuity of Service mission
<b>EO</b>	Earth Observation		
<b>EPS</b>	Energy and Power Subsystem	<b>L1</b>	Level-1 Product
<b>EQSOL</b>	Emergency Quick Switch Offline	<b>L2</b>	Level-2 Product
<b>ERCS</b>	Emergency Response Core Service	<b>LAI</b>	Leaf area index
<b>ERS</b>	European Radar Satellite System	<b>LC</b>	Land colour
<b>ESA</b>	European Space Agency	<b>LEOP</b>	Launch and Early Orbit Phase
<b>ESAM</b>	Emergency Safe Acquisition Mode	<b>LMCS</b>	Land Monitoring Core Service (Euroland, Geoland-2)
<b>ESOC</b>	European Space Operations Centre	<b>LRM</b>	Low-Resolution Mode
<b>ESRIN</b>	European Space Research Institute	<b>LRR</b>	Laser Retro-Reflector
		<b>LST</b>	Land Surface Temperature
		<b>LTAN</b>	Local Time of Ascending Node

<b>LTDN</b>	Local Time of Descending Node
<b>LVDS</b>	Low-Voltage Differential Signal
<b>MARISS</b>	European Maritime Security Services
<b>MCS</b>	Marine Core Service
<b>MERIS</b>	Medium-Resolution Imaging Spectrometer (Envisat)
<b>MetOp</b>	Meteorological Operational satellite programme
<b>MLI</b>	Multilayer Insulation
<b>MODIS</b>	Moderate-resolution Imaging Spectroradiometer (Aqua)
<b>MOS</b>	Modular Optoelectronic Scanner (IRS-P2)
<b>MRD</b>	Mission Requirements Document
<b>MRTD</b>	Mission Requirements Traceability Document
<b>MSG</b>	Meteosat Second Generation
<b>MTB</b>	Magnetic Torque Bar
<b>MTG</b>	Meteosat Third Generation
<b>MWR</b>	Microwave Radiometer
<b>NASA</b>	National Aeronautics and Space Administration (USA)
<b>NEΔT</b>	Noise-Equivalent Temperature Difference
<b>NEMO</b>	Nucleus for European Modelling of the Ocean
<b>NOAA</b>	National Oceanic and Atmospheric Administration (USA)
<b>NOP</b>	Numerical Ocean Prediction
<b>NPP</b>	National Polar-orbiting Operational Environmental Satellite System Preparatory Project (NASA)
<b>NRT</b>	Near-realtime
<b>NTC</b>	Non-time critical
<b>NWP</b>	Numerical Weather Prediction
<b>OBT</b>	Onboard Time
<b>OC</b>	Ocean Colour
<b>OCTI</b>	OLCI Chlorophyll Terrestrial Index
<b>OEU</b>	OLCI Electronic Unit
<b>OL</b>	Open loop
<b>OLC</b>	Ocean and Land Colour
<b>OLCI</b>	Ocean and Land Colour Instrument
<b>OME</b>	Opto-Mechanical Enclosure
<b>ORAC</b>	Oxford–RAL Aerosol and Cloud
<b>PAR</b>	Photosynthetically Active Radiation
<b>PCDU</b>	Power Conditioning and Distribution Unit
<b>PDGS</b>	Payload Data Ground Segment
<b>PDHT</b>	Payload Data Handling and Transmission
<b>PDHU</b>	Payload Data Handling Unit
<b>PFM</b>	Proto-Flight Model
<b>PIM</b>	Payload Integration Module
<b>POD</b>	Precise Orbit Determination
<b>PRF</b>	Pulse Repetition Frequency
<b>PROM</b>	Programmable Read Only Memory
<b>PTFE</b>	Polytetrafluoroethylene
<b>RA-2</b>	Radar Altimeter-2 (Envisat)
<b>RAL</b>	Rutherford–Appleton Laboratory (UK)
<b>REU</b>	Radiometer Electronics Unit
<b>RF</b>	Radio Frequency
<b>RFFE</b>	Radio Frequency Front End
<b>RFU</b>	Radio Frequency Unit
<b>RMS</b>	Root mean square
<b>RPM</b>	Radiometer Processing Module
<b>Rx/Tx</b>	Receive and Transmit
<b>S-3</b>	Sentinel-3
<b>SADM</b>	Solar Array Drive Mechanism
<b>SAPT</b>	Standard Accuracy Pressure Transducer
<b>SAR</b>	Synthetic Aperture Radar
<b>SeaWIFS</b>	Sea-viewing Wide Field-of-view Sensor
<b>SEVIRI</b>	Spinning Enhanced Visible Infrared Imager (MSG)
<b>SIOV</b>	Satellite In-Orbit Verification
<b>SIRAL</b>	Synthetic Aperture Interferometric Radar Altimeter
<b>SLCPE</b>	SLSTR Control and Processor Electronics
<b>SLOSU</b>	SLSTR Optical Scanning Unit
<b>SLST</b>	Sea, Land and ice Surface Temperature
<b>SLSTR</b>	Sea and Land Surface Temperature Radiometer
<b>SMU</b>	Satellite Management Unit
<b>SNR</b>	Signal to Noise Ratio
<b>SPOT</b>	Système Probatoire d’Observation de la Terre/Satellite pour l’Observation de la Terre
<b>SRAL</b>	SAR Radar ALtimeter
<b>SPOT</b>	Système Probatoire d’Observation de la Terre
<b>SSALTO–SALP</b>	Segment Sol multi-missions d’Altimétrie, d’Orbitographie et de Service d’Altimétrie et Localisation Précise
<b>SSH</b>	Sea Surface Height/Topography
<b>SSHA</b>	Sea Surface Height Anomaly
<b>SSP</b>	Sub-Satellite Point
<b>SSPA</b>	Solid State Power Amplifier
<b>SST</b>	Sea Surface Temperature
<b>STC</b>	Short Time Critical
<b>STM</b>	Structural and Thermal Model
<b>SVF</b>	Software Validation Facility
<b>SWH</b>	Significant Wave Height
<b>SWIR</b>	Short-Wave Infrared
<b>SWSA</b>	Scrambling Window Assembly
<b>TAI</b>	International Atomic Time
<b>TAS-F</b>	Thales Alenia Space, France
<b>TAS-I</b>	Thales Alenia Space, Italy
<b>TC</b>	Telecommand
<b>TIR</b>	Thermal Infrared
<b>TIROS</b>	Thermal and Infrared Observation Satellite (NOAA)
<b>TM</b>	Telemetry
<b>TM/TC</b>	Telemetry/Telecommand
<b>TOA</b>	Top-of-Atmosphere



<b>TOPEX</b>	Ocean Topography Experiment (NASA/ CNES)	<b>VIIRS</b>	Visible Infrared Imager Radiometer Suite (NPP)
<b>TTC</b>	Telemetry and Telecommand	<b>VNIR</b>	Visible and Near-Infrared
<b>TXA</b>	X-band Assembly	<b>VIS</b>	Visible
<b>USO</b>	Ultrastable Oscillator	<b>VISCAL</b>	Visible Calibration Unit
<b>UTC</b>	Coordinated Universal Time	<b>WGS 84</b>	World Geodetic System, standard Earth fixed reference frame
<b>VAM</b>	Video Acquisition Module		



A list of 15 ESA Member States, including Austria, Belgium, Czech Republic, Denmark, Finland, France, Germany, Greece, Ireland, Italy, Luxembourg, Netherlands, Norway, Portugal, Romania, Spain, Sweden, Switzerland, and United Kingdom. The list is positioned to the right of a white circle where three white curved lines intersect on a blue background.

## ESA Member States

Austria

Belgium

Czech Republic

Denmark

Finland

France

Germany

Greece

Ireland

Italy

Luxembourg

Netherlands

Norway

Portugal

Romania

Spain

Sweden

Switzerland

United Kingdom